

# 2475 Multi $\lambda$ Fluorescence Detector Operator's Guide

71500247502/Revision F



Copyright © Waters Corporation 2010  
All rights reserved

## Copyright notice

---

© 2010 WATERS CORPORATION. PRINTED IN THE UNITED STATES OF AMERICA AND IN IRELAND. ALL RIGHTS RESERVED. THIS DOCUMENT OR PARTS THEREOF MAY NOT BE REPRODUCED IN ANY FORM WITHOUT THE WRITTEN PERMISSION OF THE PUBLISHER.

The information in this document is subject to change without notice and should not be construed as a commitment by Waters Corporation. Waters Corporation assumes no responsibility for any errors that may appear in this document. This document is believed to be complete and accurate at the time of publication. In no event shall Waters Corporation be liable for incidental or consequential damages in connection with, or arising from, its use.

## Trademarks

---

Alliance, Millennium, and Waters are registered trademarks, and Empower, LAC/E, SAT/IN, and “THE SCIENCE OF WHAT’S POSSIBLE.” are trademarks of Waters Corporation.

Teflon is a registered trademark of E. I. du Pont de Nemours and Company.

Windows and Windows NT are registered trademarks of Microsoft Corporation.

Other registered trademarks or trademarks are the sole property of their owners.

## Customer comments

---

Waters' Technical Communications department invites you to tell us of any errors you encounter in this document or to suggest ideas for otherwise improving it. Please help us better understand what you expect from our documentation so that we can continuously improve its accuracy and usability.

We seriously consider every customer comment we receive. You can reach us at [tech\\_comm@waters.com](mailto:tech_comm@waters.com).

## Contacting Waters

---

Contact Waters<sup>®</sup> with enhancement requests or technical questions regarding the use, transportation, removal, or disposal of any Waters product. You can reach us via the Internet, telephone, or conventional mail.

### Waters contact information

Contacting medium	Information
Internet	The Waters Web site includes contact information for Waters locations worldwide. Visit <a href="http://www.waters.com">www.waters.com</a> .
Telephone and fax	From the USA or Canada, phone 800 252-HPLC, or fax 508 872 1990. For other locations worldwide, phone and fax numbers appear in the Waters Web site.
Conventional mail	Waters Corporation 34 Maple Street Milford, MA 01757 USA

## Safety considerations

---

Some reagents and samples used with Waters instruments and devices can pose chemical, biological, and radiological hazards. You must know the potentially hazardous effects of all substances you work with. Always follow

Good Laboratory Practice, and consult your organization's safety representative for guidance.

## Safety advisories







Consult [Appendix A](#) for a comprehensive list of warning and caution advisories.

## Operating this instrument

---

When operating this instrument, follow standard quality-control (QC) procedures and the guidelines presented in this section.

## Applicable symbols

Symbol	Definition
 Waters Corporation 34 Maple Street, Milford, MA 01857, U.S.A.	Manufacturer
 EC REP Waters Corporation 34 Maple Street Milford, MA 01857 U.S.A.	Authorized representative of the European Community
	Confirms that a manufactured product complies with all applicable European Community directives
	Australia C-Tick EMC Compliant
	Confirms that a manufactured product complies with all applicable United States and Canadian safety requirements
	Consult instructions for use

## Audience and purpose

This guide is intended for personnel who install, operate, and maintain the 2475 Multi  $\lambda$  Fluorescence detector.

## Intended use of the instrument

Waters designed the 2475 Multi  $\lambda$  Fluorescence Detector to analyze samples in high-performance liquid chromatography (HPLC) applications. The 2475 Multi  $\lambda$  Fluorescence detector is for research use only

## Calibrating

To calibrate LC systems, follow acceptable calibration methods using at least five standards to generate a standard curve. The concentration range for standards should include the entire range of QC samples, typical specimens, and atypical specimens.

When calibrating mass spectrometers, consult the calibration section of the operator's guide for the instrument you are calibrating. In cases where an overview and maintenance guide, not operator's guide, accompanies the instrument, consult the instrument's online Help system for calibration instructions.

## Quality-control

Routinely run three QC samples that represent subnormal, normal, and above-normal levels of a compound. Ensure that QC sample results fall within an acceptable range, and evaluate precision from day to day and run to run. Data collected when QC samples are out of range might not be valid. Do not report these data until you are certain that the instrument performs satisfactorily.

## ISM classification

---

### ISM Classification: ISM Group 1 Class B

This classification has been assigned in accordance with CISPR 11 Industrial Scientific and Medical (ISM) instruments requirements. Group 1 products apply to intentionally generated and/or used conductively coupled radio-frequency energy that is necessary for the internal functioning of the equipment. Class B products are suitable for use in both commercial and residential locations and can be directly connected to a low voltage, power-supply network.

## EC authorized representative

---



Waters Corporation (Micromass UK Ltd.)  
Floats Road  
Wythenshawe  
Manchester M23 9LZ  
United Kingdom

Telephone: +44-161-946-2400  
Fax: +44-161-946-2480  
Contact: Quality manager

# Table of Contents

---

Copyright notice .....	ii
Trademarks .....	ii
Customer comments .....	iii
Contacting Waters .....	iii
Safety considerations .....	iii
Safety advisories .....	iv
Operating this instrument .....	iv
Applicable symbols .....	iv
Audience and purpose.....	iv
Intended use of the instrument.....	v
Calibrating .....	v
Quality-control .....	v
ISM classification .....	v
ISM Classification: ISM Group 1 Class B .....	v
EC authorized representative .....	vi
<b>1 Theory of Operation .....</b>	<b>1-1</b>
Fluorescence theory .....	1-2
Fluorescence detection .....	1-3
Overview.....	1-3
Excitation sources.....	1-3
Types of light sources .....	1-3
Excitation wavelength selection .....	1-3
Exciting the sample .....	1-4
Flow cell.....	1-4
Measuring fluorescence .....	1-4
Quantitation.....	1-4
Emission wavelength selection .....	1-4

Photomultiplier tube.....	1-4
Scanning.....	1-5
Multichannel operation .....	1-5
Fluorescence data .....	1-5
References .....	1-6
<b>Detector description .....</b>	<b>1-7</b>
Features.....	1-7
<b>Principles of operation .....</b>	<b>1-9</b>
Detector optics.....	1-9
Optics assembly light path.....	1-10
Photomultiplier (PMT) calibration .....	1-12
PMT sensitivity.....	1-12
Filtering noise .....	1-12
Electronics.....	1-13
Wavelength verification and test.....	1-14
<b>Operational modes .....</b>	<b>1-14</b>
Single-channel mode.....	1-14
Multichannel mode .....	1-15
<b>Spectrum scanning .....</b>	<b>1-16</b>
<b>Lamp energy and performance .....</b>	<b>1-16</b>
<b>Auto-optimize gain .....</b>	<b>1-17</b>
Method optimization.....	1-18
Example of recommended method development approach.....	1-19
Ensuring gain optimization for each peak of interest .....	1-20
<b>Startup diagnostic tests .....</b>	<b>1-21</b>
<b>Mobile-phase solvent degassing .....</b>	<b>1-21</b>
<b>Wavelength selection .....</b>	<b>1-22</b>
<b>2 Setting Up the Detector .....</b>	<b>2-1</b>
Before you begin .....	2-2
Installing the detector .....	2-3



<b>Plumbing the detector</b> .....	<b>2-3</b>
Connecting columns.....	2-3
Assembling fittings.....	2-4
Making tubing connections .....	2-5
<b>Making signal connections</b> .....	<b>2-5</b>
Component connection overview.....	2-6
Connecting the Ethernet cable.....	2-7
Choosing signal connections.....	2-10
Making I/O signal connections.....	2-11
Signal connections .....	2-12
Connecting an Alliance separations module .....	2-14
Connecting RS-232 devices .....	2-18
Connecting Ethernet devices.....	2-20
<b>Connecting other devices</b> .....	<b>2-23</b>
Required materials .....	2-23
Connecting cables .....	2-23
Connecting a data system using a Bus SAT/IN module.....	2-24
Connecting a 746 data module.....	2-27
Connecting a chart recorder.....	2-28
Connecting a 600-series pump .....	2-29
Connecting a 717plus Autosampler .....	2-33
<b>Connecting to the electricity source</b> .....	<b>2-36</b>
<b>3 Using the Detector</b> .....	<b>3-1</b>
<b>Starting the detector</b> .....	<b>3-2</b>
Initializing the detector.....	3-2
Startup failure .....	3-3
Idle mode .....	3-4
<b>Using the operator interface</b> .....	<b>3-4</b>
Using the display .....	3-4
Fluorescence and message icons .....	3-5
Using the keypad .....	3-9
Navigating the user interface .....	3-16
Navigating to and from the home screen.....	3-16

<b>Preparing to start a run .....</b>	<b>3-18</b>
Setting up a run .....	3-18
Accessing primary and secondary functions .....	3-19
Operating the trace and scale functions .....	3-23
Configuring the detector.....	3-25
Configuring event inputs and contact closures .....	3-25
Setting pulse periods .....	3-26
Setting the Display Contrast .....	3-27
Displaying system information .....	3-28
Using Online Help .....	3-28
<b>Operating the detector .....</b>	<b>3-28</b>
Two operating modes.....	3-29
Standalone operation.....	3-29
Remote control operation for 474 emulation mode via RS-232 .....	3-29
Remote control operation via Ethernet connection using 2475 instrument control software.....	3-34
Verifying the detector .....	3-34
Manual wavelength calibration .....	3-35
Normalizing emission units .....	3-36
Operating the detector in single-channel mode .....	3-37
Operating the detector in multichannel mode .....	3-38
Setting gain and EUFS.....	3-40
<b>Programming methods and events .....</b>	<b>3-43</b>
Storing methods.....	3-43
Programming timed events .....	3-44
Programming threshold events.....	3-47
Storing a method.....	3-49
Retrieving a method .....	3-50
Viewing events within a method.....	3-50
Resetting a method.....	3-51
Clearing events .....	3-51
<b>Scanning spectra .....</b>	<b>3-52</b>
Types of scanning.....	3-52
Before you begin.....	3-52
Scanning new spectra.....	3-57

Parameters used for sample and zero-scans .....	3-58
Programming a zero-scan.....	3-59
Running a sample scan.....	3-60
Scanning using a static flow cell.....	3-64
<b>Managing results .....</b>	<b>3-65</b>
Storing a spectrum.....	3-65
Getting information about a stored spectrum.....	3-66
Reviewing a stored spectrum .....	3-66
Creating a difference spectrum (subtracting a spectrum).....	3-67
Replaying a spectrum .....	3-67
<b>Conserving lamp life .....</b>	<b>3-67</b>
Manually extinguishing the lamp.....	3-68
Manually lighting the lamp.....	3-69
Using a timed event method to program the lamp .....	3-70
<b>Shutting down the detector .....</b>	<b>3-70</b>
<b>4 Maintenance Procedures .....</b>	<b>4-1</b>
<b>Contacting Waters technical service .....</b>	<b>4-2</b>
<b>Maintenance considerations .....</b>	<b>4-2</b>
Safety and handling.....	4-2
Spare parts.....	4-3
<b>Routine maintenance .....</b>	<b>4-3</b>
Removing the front-left-hand panel cover .....	4-4
<b>Inspecting, cleaning, and replacing the flow cell .....</b>	<b>4-5</b>
Flushing and passivating the flow cell .....	4-5
Removing the flow cell assembly .....	4-6
Replacing the flow cell.....	4-7
<b>Replacing the lamp .....</b>	<b>4-8</b>
When to replace the lamp.....	4-8
Removing the lamp.....	4-9
Installing the new lamp.....	4-12
Recording the new lamp's serial number .....	4-13

Replacing the fuses .....	4-14
Cleaning the instruments exterior .....	4-15
<b>5 Error Messages, Diagnostic Tests, and Troubleshooting .....</b>	<b>5-1</b>
Startup error messages .....	5-2
Operational error messages .....	5-3
<b>User-selected diagnostic tests and settings .....</b>	<b>5-8</b>
Overview of diagnostic tests and settings .....	5-8
Sample and reference energy diagnostic tests .....	5-11
Raman signal-to-noise test diagnostic test.....	5-12
Input and output diagnostic tests and settings .....	5-12
Change-lamp function .....	5-15
Testing the keypad .....	5-16
Testing the display .....	5-17
Other diagnostic tests and settings .....	5-17
Generating test peaks.....	5-17
Overriding the optical filter setting.....	5-18
Reducing PMT sensitivity .....	5-19
<b>Troubleshooting .....</b>	<b>5-20</b>
Introduction.....	5-20
Information needed when you contact Waters.....	5-20
Diagnostic tests.....	5-21
Power surges .....	5-21
Hardware troubleshooting .....	5-21
<b>A Safety Advisories .....</b>	<b>A-1</b>
<b>Warning symbols .....</b>	<b>A-2</b>
Task-specific hazard warnings.....	A-2
Specific warnings .....	A-3
<b>Caution symbol .....</b>	<b>A-5</b>
<b>Warnings that apply to all Waters instruments .....</b>	<b>A-6</b>
<b>Electrical and handling symbols .....</b>	<b>A-12</b>

Electrical symbols .....	A-12
Handling symbols .....	A-13
<b>B Specifications .....</b>	<b>B-1</b>
<b>C Solvent Considerations .....</b>	<b>C-1</b>
<b>Introduction .....</b>	<b>C-2</b>
Clean solvents .....	C-2
Solvent quality .....	C-2
Preparation checklist.....	C-2
Water .....	C-2
Buffers .....	C-3
Tetrahydrofuran (THF) .....	C-3
<b>Solvent miscibility .....</b>	<b>C-3</b>
How to use miscibility numbers.....	C-5
<b>Buffered solvents .....</b>	<b>C-6</b>
<b>Head height .....</b>	<b>C-6</b>
<b>Solvent viscosity .....</b>	<b>C-6</b>
<b>Mobile phase solvent degassing .....</b>	<b>C-7</b>
Gas solubility .....	C-7
Solvent degassing methods .....	C-8
Solvent degassing considerations .....	C-9
<b>Wavelength selection .....</b>	<b>C-9</b>
UV cutoffs for common solvents.....	C-10
<b>Index .....</b>	<b>Index-1</b>



# 1 Theory of Operation

This chapter explains the theory and technology supporting the operation of the Waters® 2475 Multi  $\lambda$  Fluorescence Detector and describes the instrument's features.

## Contents:

Topic	Page
Fluorescence theory	1-2
Fluorescence detection	1-3
Measuring fluorescence	1-4
Detector description	1-7
Principles of operation	1-9
Operational modes	1-14
Spectrum scanning	1-16
Lamp energy and performance	1-16
Auto-optimize gain	1-17
Startup diagnostic tests	1-21
Mobile-phase solvent degassing	1-21
Wavelength selection	1-22

## Fluorescence theory

---

*Fluorescence* occurs when certain molecules absorb light at specific wavelengths, promoting the molecules to a higher energy state. As they return to their normal energy states, the “excited” molecules release their absorbed energy as photons.

Many organic compounds absorb light, but few fluoresce. HPLC systems that incorporate fluorescence detection effectively identify polyaromatic hydrocarbons, aflatoxins, vitamins, amino acids, and so on. Chemical derivatization methods extend fluorescence detection to some nonfluorescing compounds such as carbamate pesticides.

Fluorescence detection requires both the excitation/emission wavelengths, leading to a higher degree of sensitivity. As a result, this technique is useful for analyses requiring low detection limits.

Certain conditions can interfere with a compound’s ability to fluoresce, diminishing analytical performance:

- pH changes – The loss or gain of protons and their accompanying increase or decrease of charge affects an analyte’s electronic structure and can enhance or degrade fluorescence.
- Temperature changes – Fluorescence decreases as the sample temperature increases.
- Changes in the amount of dissolved oxygen – For some molecules, fluorescence is quenched (decreased) by the presence of dissolved oxygen.

Fluorescence detectors can be adapted to measure chemiluminescence, where a molecule without exposure to any excitation energy emits a low intensity signal. This type of detection can be accommodated by disabling the light source or (as in the case of the 2475 detector) enabling a shutter to stop any excitation light from reaching the flow cell.

The process of fluorescence detection involves an excitation source and the following processes:

- Filtering the source light
- Exciting the sample with filtered light
- Collecting and filtering the emitted fluorescence



- Measuring the emitted fluorescence
- Amplifying the emitted signal

## Fluorescence detection

---

### Overview

The scanning fluorescence detector illuminates a sample with a narrow band of high-intensity light. The detector then measures the low levels of fluorescence emitted by the sample. The emitted light is filtered, amplified, and converted to electrical signals that can be recorded and analyzed.

### Excitation sources

The typical energy source used for fluorescence detection is a lamp that provides an intense, stable spectrum of light in the UV and visible ranges. The resulting fluorescence intensity is directly related to the intensity of the excitation spectrum. Thus high-sensitivity detectors use the most intense excitation source available.

### Types of light sources

Xenon lamps are the preferred source for general-purpose fluorescence detectors.

### Excitation wavelength selection

The excitation wavelength of choice requires some source-light filtering. In modern detectors, a monochromator is typically used for the same purpose.

A monochromator is an adjustable device that you use to select wavelengths over a wide range of the spectrum. A grating monochromator uses a diffraction grating that passes only a small range, or bandwidth, of wavelengths. By moving the grating, you can select wavelengths within a particular range of wavelengths. A grating monochromator also passes fractions, or orders, of a selected wavelength. For example, if the monochromator is set to pass light energy at 600 nm, it also passes energy at the second-order wavelength of 300 nm. A long-pass filter can be used to absorb the higher-order energy produced by a monochromator. As the excitation is selected by a monochromator, the emission (radiated energy) can

also be selected. Detectors with excitation and emission monochromators can scan holding one monochromator at a constant setting while varying the setting on the other. This type of operation is necessary when you are evaluating mixtures or analyzing chemical structures.

## Exciting the sample

The broad band of high-intensity light from the lamp passes through a filter or monochromator, which selects a narrow band of wavelengths. This narrow band of light is then directed onto the flow cell where it excites the analytes as they pass through. Excitation wavelengths often correspond with the absorbance wavelength of the analyte.

## Flow cell

The quartz flow cell minimizes the amount of stray light that can affect the measurement, and it maximizes the fluorescence signal. The sample compartment is arranged so that the fluorescence energy is collected at an angle perpendicular to the excitation (lamp) beam. This arrangement minimizes the effect of Rayleigh scatter on background light levels.

## Measuring fluorescence

---

To measure fluorescence in the flow cell, the detector must balance the need for high selectivity (to distinguish specific fluorescence wavelengths) with the need for high sensitivity (to measure low-fluorescence intensities).

## Quantitation

Fluorescence is linear at low concentrations but can exhibit nonlinearity at high concentrations.

## Emission wavelength selection

A monochromator is used to select an emission wavelength.

## Photomultiplier tube

The photomultiplier tube (PMT) produces a current proportional to the flux of photons emitted by the molecules in the flow cell.

## Scanning

Detectors equipped with excitation and emission monochromators can easily scan a range of excitation or emission wavelengths. Changing the wavelength involves changing the monochromator setting. During a scan, the setting on one monochromator is held constant while the other monochromator scans a range of wavelengths.

## Multichannel operation

Detectors equipped with excitation and emission monochromators can change the wavelength of the excitation and emission settings. In multichannel operation, both monochromators move rapidly between the selected wavelength pairs to produce multiple chromatogram traces. Multiple outputs can then derive additional information from a single separation.

## Fluorescence data

Detectors report their data in units of fluorescence intensity (emission) or energy. In addition, the 2475 detector reports intensity using normalized units to compensate for variability between individual detectors and offset any age-related decrease in lamp intensity. When using normalized units, changes in gain improve the signal-to-noise ratio but do not change the peak response, conferring a high degree of bench-to-bench reproducibility of fluorescent signal measurements.

### Emission units and normalization

The 2475 detector offers two types of output units: emission and energy. Emission units are normalized to a standard water reference, and their magnitude is as independent of the PMT gain as possible. You can compensate for changes that normally influence the signal strength of fluorescence measurements, such as lamp or optics degradations, by periodically renormalizing to the standard water reference. Renormalizing reduces variations in fluorescence signal strengths from one detector to another.

The following equation calculates the emission units value (EU) at any time (t):

$$EU_t = (\text{PMTCounts}_t / \text{Gain}_t) \times (\text{Gain}_{\text{Raman}} / \text{Counts}_{\text{Raman}}) \times 100$$

where

$\text{Gain}_{\text{Raman}}$  and  $\text{Counts}_{\text{Raman}}$  = values from the most recent execution of the normalize units function

$\text{PMTCounts}_t$  and  $\text{Gain}_t$  = values at the time of data collection

Normalizing the emission units results in a water/Raman signal strength, at  $E_x$  350 nm/ $E_m$  397 nm, of 100 emission units. The xenon spectrum output is not uniform over the detector's operating range, and low-UV wavelengths can degrade faster than normalization wavelengths.

## Energy units

The alternative to emission units is energy units, which are similar to those used by traditional HPLC fluorescence detectors. They directly correlate to the anode current of the PMT, so they are directly influenced by the gain setting. All instrumental variables, such as lamp intensity, optics efficiency, and gain, directly influence the fluorescence emission signal strength. As a result, energy units are less reliable. Nonetheless, when you must calculate energy units to conform to established protocols, use the following equation:

$$\text{EU} = \text{PMTCounts} \times K \times (\text{ReferenceCounts}_0 / \text{ReferenceCounts}_t)$$

where K scales the maximum detectable fluorescence signal to 10,000 units.

## References

Consult the following texts for additional information on fluorescence detection:

N. Ichinose, G. Schwedt, F. M. Schnepel, and K. Adachi, *Fluorometric Analysis in Biomedical Chemistry*, Chapter 5, Wiley-Interscience: New York, 1991.

E. S. Yeung, ed., *Detectors for Liquid Chromatography*, Chapter 5, Wiley: New York, 1986.

W. R. Seitz, in *Treatise on Analytical Chemistry*, 2nd ed., P. J. Elving, E. J. Meehan, I. M. Kolthoff, eds., Part I, Vol. 7, Chapter 4, Wiley: New York, 1981.

J. R. Lakowicz, *Principles of Fluorescence Spectroscopy*, Plenum: New York, 1983.

S. G. Schulman, *Fluorescence and Phosphorescence Spectroscopy: Physicochemical Principles and Practice*, Pergamon Press: New York, 1977.

J. D. Winefordner, S. G. Schulman, and T. C. O'Haver, *Luminescence Spectroscopy in Analytical Chemistry*, Wiley-Interscience: New York, 1972.

## Detector description

---

The 2475 Multi  $\lambda$  Fluorescence Detector is a multichannel, tunable, fluorescence detector designed for high-performance liquid chromatography (HPLC) applications.

### Waters 2475 Multi $\lambda$ Fluorescence Detector

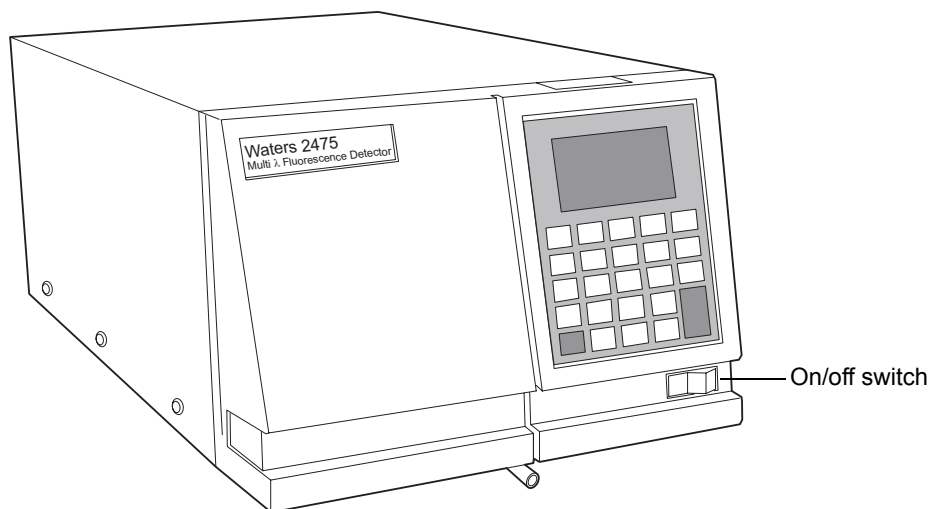

## Features

The detector operates from 200 to 900 nm. It uses optics designed with an enhanced illumination system optimized for LC performance. The following

design features increase the optical throughput and sensitivity, resulting in an overall increase in the signal-to-noise ratio:

- Standalone programmability – Stores up to 10 user-defined programs (or methods), each consisting of up to 48 programmable, timed events and 2 programmable switches.
- Single or multichannel mode – Monitors fluorescence at one or more discrete wavelength pairs.
- Integral erbium calibration reference – Ensures wavelength accuracy.
- Automatic second-order filter – Automatically engaged for wavelengths of 400 nm and greater and removed for wavelengths of 399 nm or less.
- Spectrum scan and storage display – Supports spectrum scan, display, and subtraction in addition to standard tunable fluorescence functionality.
- Full diagnostic capability – Supports built-in diagnostic tools to optimize functionality and performance.
- Data communications and control – By an Empower™ system or Millennium®<sup>32</sup> chromatography workstation (version 3.2 or 4.0).
- Backward compatibility – Operates as a 474 Detector with an Empower system or Millennium<sup>32</sup> chromatography workstation version, 3.2 or 4.0, using RS-232, serial communication.
- Two programmable contact closure outputs – Has two configurable switches, each of which can accommodate a maximum of +30 V and 1 A. The switches (SW1 and SW2) can trigger fraction collectors and other external devices. Time and fluorescence can actuate the switches.
- Normalized emission units – Enhances unit to unit reproducibility.
- Idle mode – Closes a shutter to prevent degradation of the optics.
- Fast Scan mode – Dynamically scans either the emission or excitation grating through a selectable wavelength range to monitor the fluorescence of a series of wavelengths. (This feature is available only in Empower systems through remote Ethernet interface with 2475 ICS software control.)

# Principles of operation

---

To use the detector effectively, you should be familiar with the optical and electronic design of the detector and the theory and principles of operation.

- Optics
- Wavelength verification and test
- Flow cell
- Electronics

## Detector optics

The optics are based on a pair of tunable monochromators and include the following parts:

- Xenon arc lamp
- Two ellipsoidal mirrors and one parabolic mirror
- Shutter, wavelength calibration filter, and second-order filter
- Entrance slits
- Exit slits
- Blazed, plane, and concave holographic diffraction gratings
- Photomultiplier tube (PMT)
- Waters axially illuminated flow cell

The following diagrams show the optics assembly light paths and components.

### Excitation monochromator optics assembly

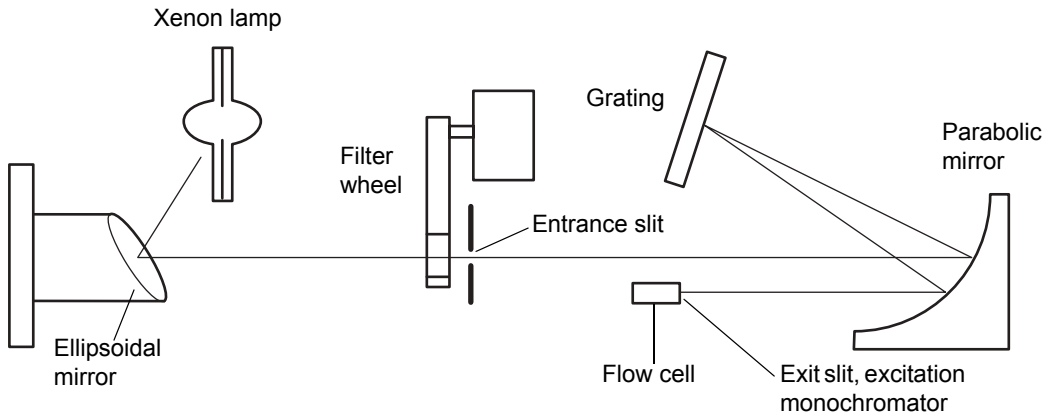

### Emission monochromator optics assembly

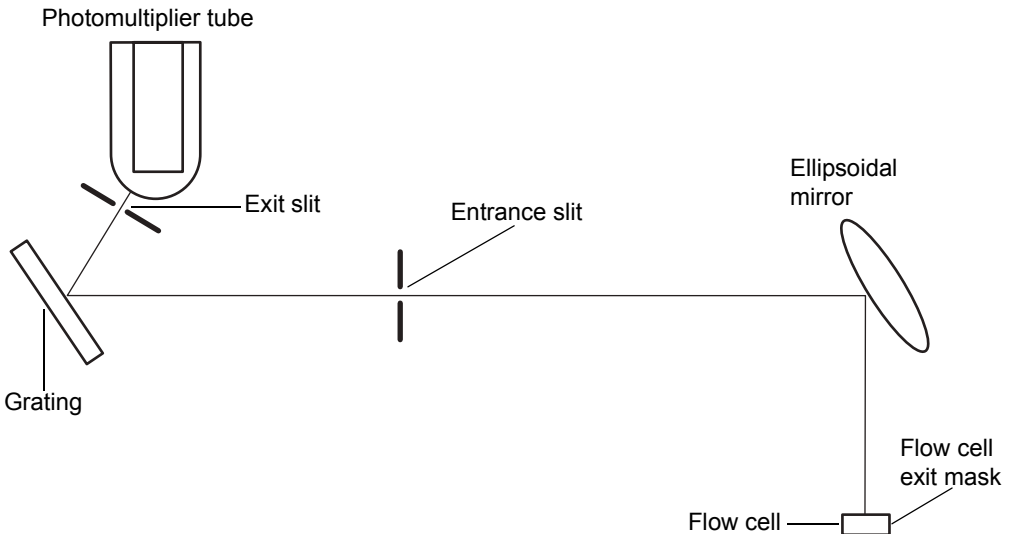

### Optics assembly light path

The detector demonstrates superior performance by employing several unique design elements. Its novel flow cell design minimizes stray background light



and increases the detectability of low-level signals. Keeping the optics simple tends to minimize loss of signal and maximize throughput.

## Light source

The detector uses a high-intensity 150-watt xenon arc lamp as its source. The emitted light passes through the excitation monochromator to flood the aperture of the flow cell. The lamp light is collected by an elliptical mirror behind the lamp, its center of curvature oriented toward the lamp's bright spot.

## Excitation monochromator

The detector uses a monochromator to select the appropriate excitation wavelengths defined by its geometry. The grating can rotate quickly, responding to multiple excitation wavelengths and/or scanning.

## Emission monochromator

The light emitted by the sample travels from the top of the flow cell into the emission optics. The emission optics are positioned at right angles to the excitation source to minimize the possibility of stray light reaching the PMT. The emission monochromator selects the appropriate emission wavelengths.

## Axially illuminated flow cell

The flow cell design incorporates an axially illuminated, fused-quartz flow cell.

## Axially illuminated flow cell

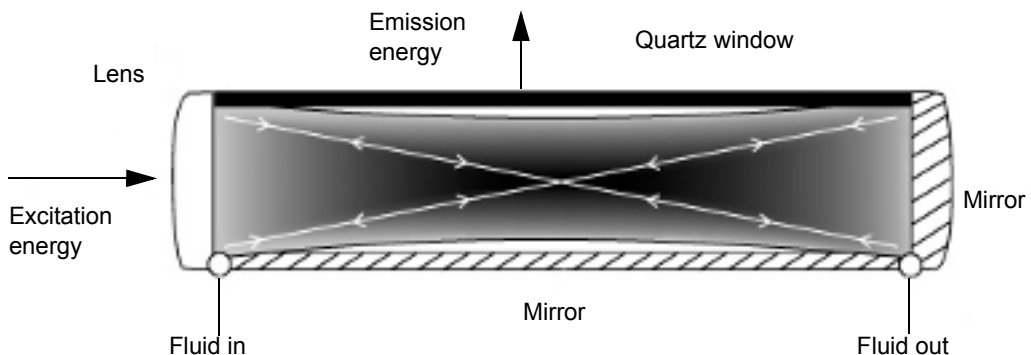

The excitation energy is focused on a geometrically matched mirror whose shape is opposite that of the excitation energy entrance lens. Excitation energy is reflected along the flow cell axis and back, effectively doubling the pathlength of the cell. The increased pathlength in turn provides superior sensitivity compared to traditional fluorescence detectors.

## Photomultiplier (PMT) calibration

The sensitivity of the detector is controlled by the gain setting, which increases the voltage to the PMT to amplify and increase response. The gain is achieved by controlling the high-voltage supply to the PMT. After the assembly and alignment of the detector and whenever the PMT or any PC boards are replaced, Waters personnel calibrate PMTs using an onboard service diagnostic function.

## PMT sensitivity

After calibrating the PMT, you must choose a gain setting for the photomultiplier tube prior to a chromatographic injection. Saturation, which occurs when the sample concentration is high, or the experimental mobile phase has a high background, is always a concern—even when the PMT gain setting is at the lowest level. For this reason, the 2475 detector's Auto Optimize Gain diagnostic function lets you adjust the granularity of the gain.

## Filtering noise

The detector uses a digital filter to minimize noise.

Lower-time constant settings produce these effects:

- Narrow peaks appear with minimal peak distortion and time delay.
- Very small peaks become harder to discriminate from baseline noise.
- Less baseline noise is removed.

Higher time constant settings produce these effects:

- Greatly decreased baseline noise
- Shortened and broadened peaks

The software includes fast, normal, or slow filtering constants at each data rate that are appropriate for high-speed or high-sensitivity applications, respectively.

The following figure shows the relationship between increased time-constant and response times.

### Effect of filter time constant

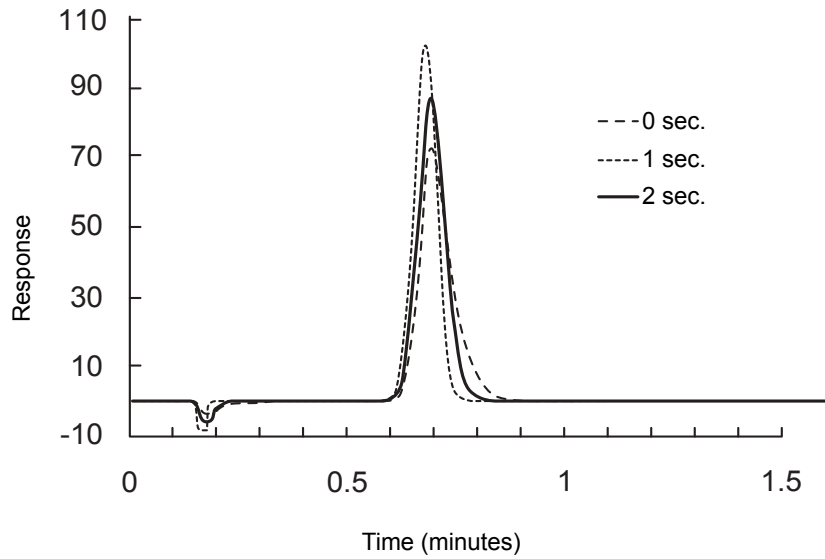

## Electronics

The electronics consist of the following components:

- Preamplifier board – Collects and processes the analog input signals from the PMT and photodiode to the microprocessor for further signal conditioning. Sample and reference signals are integrated and A/D conversion is performed simultaneously. This component ensures the best rejection of common mode noise in the two beams, leading to a quiet baseline.
- Personality board – Receives inputs from the preamplifier board and external events. It also provides control of the optics positioning subsystems and the lamp power supply.
- CPU board – Contains the digital signal processor, communication ports, nonvolatile (battery backed-up) RAM and flashable RAM space in which the firmware resides.
- Ethernet communications interface – Enables the detector to communicate with data system software.

- Lamp power supply – Provides stable xenon lamp operation.
- DC power supply – Provides voltage for the analog and digital circuitry. It is the DC power source for the detector.

## Wavelength verification and test

The xenon arc lamp and the integral erbium filter exhibit peaks in the transmission spectrum at known wavelengths. Upon startup, the detector waits 5 minutes for the xenon lamp to warm and stabilize. The detector verifies calibration by comparing the locations of these peaks with calibration data stored in memory. If the results of this verification differ from the stored calibration by more than  $\pm 2.0$  nm, the detector displays a wavelength verification failure message. This message indicates a manual wavelength calibration is necessary. The detector verifies, rather than recalibrates, to avoid errors that can occur if the flow cell contains residual materials. Calibration requires a clean flow cell and transparent mobile phase. You can initiate a manual wavelength calibration anytime to replace the previous calibration data with new data.

**Tip:** The combined wavelength accuracy specification of the detector is  $\pm 3.0$  nm, but the wavelength accuracy of each grating is held to  $\pm 2.0$  nm.

When the detector runs continuously, you should perform wavelength verification weekly by turning it off and then on again, or perform the calibrate wavelength function through the console. The verification tests require 5 minutes of lamp warmup time to stabilize the lamp.

## Operational modes

---

The detector operates in single or multichannel mode, allows spectrum scanning using a flow cell, and provides Difference and MaxPlot functions.

### Single-channel mode

The detector defaults to single-channel mode, monitoring a single channel for an excitation/emission wavelength pair. You can specify the excitation wavelength between 200 and 890 nm on channel A.

In single-channel mode, the detector automatically engages the second-order filter for excitation wavelengths of 400 nm and longer and removes it for wavelengths shorter than 399 nm. The second-order filter is an optical filter

that blocks unwanted ultraviolet (UV) light from reaching the diffraction grating, which can interfere with fluorescence detection of 400 nm and longer.

## Selecting the appropriate sampling rate

A sufficient number of points must fall across a peak to define its shape. For this reason, the definition between peaks is lost at very low sampling rates. Empower uses the index of the data point closest to the end time, minus the index of the data point closest to the start time, to calculate the Points Across Peak value for each integrated peak in the chromatogram.

**Tip:** The Points Across Peak value appears in the Peaks table, at the bottom of the Review Main window. If the Points Across Peak field is not visible, right-click anywhere in the table, and then click Table Properties. Click the Columns tab, and then scroll down to find the Points Across Peak field. Clear the check box, and then click OK.

If the Points Across Peak value for the narrowest peak of interest is less than 25, you must specify a higher sampling rate in the instrument method. If the value is greater than 50, you should specify a lower sampling rate in the instrument method.

Set the sampling rate to the lowest value required to achieve 25 or more points across the narrowest peak. Excessively high sampling rates exhibit higher noise levels.

## Multichannel mode

In multichannel, or multiwavelength mode, the detector monitors two or more excitation/emission wavelength pairs. The sampling frequency range is reduced, limiting the use of this mode to a more standard chromatography, where peaks are not excessively narrow. You can use multiwavelength mode to obtain additional information about an analyte by running a Difference Plot or a MaxPlot. The detector allows you to select up to four excitation wavelengths from 200 to 890 nm and up to four emission wavelengths from 210 to 900 nm. For the best signal-to-noise ratio, set a gain that maximizes the dynamic range of the electronics. A gain that is too high overloads the pre-amplifier, resulting in flat-topped peaks and a warning alarm.

### MaxPlot

The detector allows you to obtain a MaxPlot in multichannel mode. The MaxPlot function monitors fluorescence at the selected excitation/emission

wavelength pairs and plots the maximum fluorescence signal value for each sample component. The MaxPlot outputs the greater of the fluorescence values on the selected channels.

### Difference plot

The detector allows you to obtain a difference plot in multichannel mode. The difference plot function monitors fluorescence at user-selected excitation/emission wavelength pairs and plots the difference in signal value between them.

## Spectrum scanning

---

You can use the detector as a fluorometer to acquire spectra and store them as a file. The major difference between this detector and a double-beam spectrophotometer is that this detector employs only one flow cell rather than a simultaneous sample and reference flow cell pair. The detector obtains a fluorescence spectrum by performing the following types of scan on the flow cell:

- Zero scan – Characterizes the baseline spectrum of a solvent.
- Excitation sample scan – Subtracts the zero scan, so the displayed or charted results are of the sample's excitation spectra only.
- Emission sample scan – Subtracts the zero scan, so the displayed or charted results are of the sample's emission scan only.

To obtain an excitation or emission spectrum of a sample, run a zero scan followed by the appropriate sample scan. Typically, a zero scan is run with pure solvent. A sample scan is usually run with the analyte dissolved in the same solvent.

## Lamp energy and performance

---

In conventional designs of fluorescence detectors, the signal-to-noise performance of the instrument is directly proportional to the lamp energy input to the instrument. Lamp energy input to the detector can be affected by

- age and efficiency of the lamp.
- improperly maintained optics and/or flow cell.
- normal degradation of optical components (including the PMT).

Optical components degrade slowly over time. In conventional fluorescence detectors, response increases by incrementing the PMT gain. However, the response of the sample varies with energy throughput. If excitation energy is degraded, peak response is degraded. If excitation intensity diminishes, peak response decreases and noise increases.

During normal operation, lamps are commonly replaced when the reference energy at specific wavelength settings falls below a user-set threshold relative to initial values. The useful lamp life depends on your requirements for noise performance.

**Tip:** You should inspect the detector's general condition when you replace lamps.

Predicting when the detector's performance degrades to an unacceptable level based solely on reference energy is unsatisfactory. Each user's analyses will require different levels of sensitivity. Checking reference energy alone to evaluate performance assumes that every lamp has the same longevity, degradation patterns, and spectral output characteristics. To reduce this uncertainty, Waters designed the detector to operate as independently of lamp output as possible. After the unit has verified the calibration of the monochromator, the instrument evaluates the energy levels in a number of characteristic regions across the spectrum. The integration time of the front-end electronics is adjusted to maximize the signal within these regions. The intent is to maintain a high signal-to-noise ratio and operate with a clean signal. In this way, the instrument's sensitivity to lamp energy is virtually eliminated as a major contributor to performance.

Ultimately, the detector's performance is a function of each unique application requirements. Signal-to-noise measurements are the best way to evaluate performance and set the boundaries for acceptable operational sensitivity limits.

The 2475 detector source lamp is warranted to light and pass startup diagnostic tests for 2000 hours or 1 year from the date of purchase, whichever comes first. The detector's on-board diagnostics allow you to record lamp usage and report the lamp serial number.

## Auto-optimize gain

---

Proper PMT gain setting maximizes the signal on the internal analog-to-digital converter without exceeding its potential limit. If you specify too high a gain, the fluorescence emissions overload the signal collection

electronics. Too low a gain reduces sensitivity to emission signals, degrading signal-to-noise ratios. The detector therefore requires you to specify a gain setting for the PMT before you inject a sample. However, before the injection, you cannot know the magnitude of your fluorescence signal. Users traditionally resolve this difficulty by running several injections to determine a suitable gain setting, a tedious process, especially when they run timed event changes in gain and/or wavelength.

The Auto-Optimize Gain diagnostic function runs a trial chromatogram and displays the ideal gain values. The reported values are based on an algorithm that ensures a 2× margin against overloading the PMT and its associated electronics with variations in fluorescence intensity for concentrated samples. In the case of timed event changes in gain and/or wavelength, the report reflects adjusted values representing the ideal gain setting for each critical timed event region. You should incorporate the reported gain values in the method, including its timed event table, to optimize the method's performance.

The detector also monitors the maximum fluorescence signal level throughout the run. When you use the analog outputs during data collection, it displays a minimum EUFS value that applies to the entire chromatogram. Like the ideal gain value, the EUFS value assumes a 2× margin to account for any variations in fluorescence intensity. Based on this report, you must adjust the gain values in the method, including its timed event table, to optimize the performance of the method.

The detector also monitors the maximum fluorescence signal level throughout the entire run. It recommends a minimum EUFS value, which applies to the entire chromatogram and appears when you use the analog outputs during data collection. This value is also computed assuming a 2× margin for error.

## Method optimization

You can download a method that includes timed event changes. The timed event changes that alter gain, excitation wavelength, or emission wavelength are critical “light condition” changes, the points at which the signal peak maximum search is renewed. You must therefore enter any timed event gain changes at strategic points before peaks to improve the detector's sensitivity to peaks. The goal is to provide a retention time demarcation point at which a gain change could be tolerated without disrupting the integration of peaks in the chromatogram. Before you run the Auto-Optimize Gain diagnostic function, you must set the initial conditions. Timed events are not absolutely necessary, but this causes the detector to recommend only one gain value



setting for all peaks in the chromatogram and no segregated peak region optimization.

## Example of recommended method development approach

A method with two timed event changes optimizes the chromatogram shown below.

### Gain optimized chromatogram

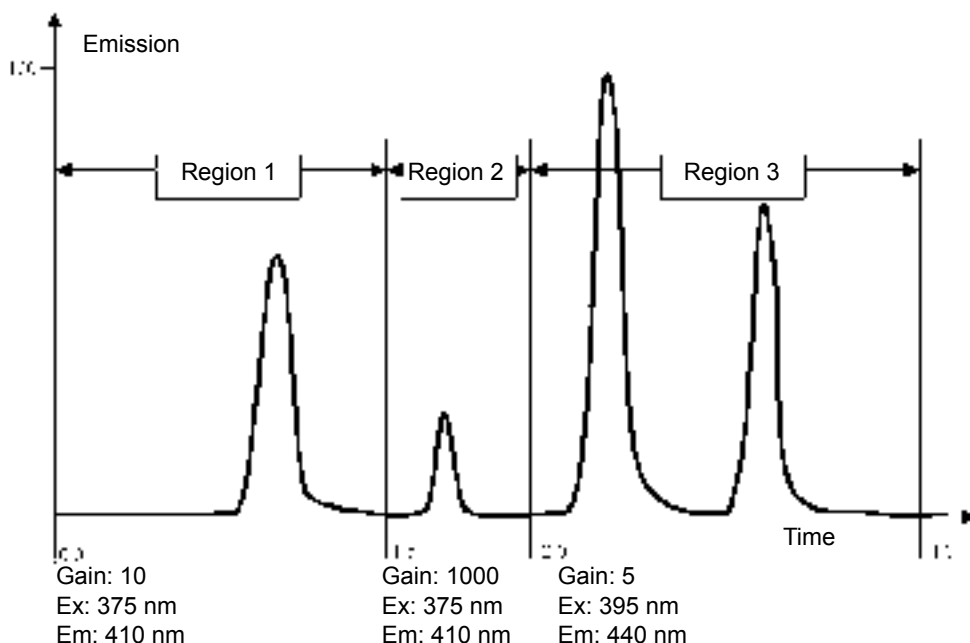

The first gain setting change occurs at 1.5 minutes, just before the small peak that is best detected at a gain of 1000. The next change, at 2.0 minutes, is the required wavelength-pair change. Initial gain setting or conditions are not critical. The only requirement for the first timed event is that some gain setting takes place. An initial method table is shown below.

### Example of method development

Time (min)	Event
Initial (0.0)	Excitation = 375 nm, Emission = 410 nm, Gain = 100
1.5	Gain = 1

## Example of method development (Continued)

Time (min)	Event
2.0	Excitation = 375 nm, Emission = 410 nm (no need to change gain here)

After you run the Auto-Optimize Gain diagnostic function, the detector displays recommended gain values.

### Recommended gain values

EUFS: 2000 event time (min.)	Best gain
0.0 (Initial)	10
1.5	1000
2.0	5

### Tips:

- The previous table contains the best gain values optimized with a 2× margin for error that holds half its capacity in reserve for unanticipated fluorescence signal fluctuations.
- The magnitude of emission units is independent of the gain, so changing gain does not affect emission unit values. However, when you use sample energy units, changing the gain does affect the magnitude of the output signal.

## Ensuring gain optimization for each peak of interest

Refer to the [figure “Gain optimized chromatogram” on page 1-19](#). If you use only one timed event (wavelength pair change at 2 minutes for peaks 3 and 4), the recommended gain table is as follows.

### Recommended gain values with a single timed event change

EUFS: 2000 event time – min.	Best gain
0.0 (Initial)	10
2.0	5

The gain for Region 2 is determined by the maximum signal level in Region 1. Therefore, a gain of only 10 would be used from time 0.0 to time 2.0, but the small peak may not be adequately resolved at this setting. If the detector did find it, the peak area integration would be far less accurate because of higher baseline noise. Failure to program a gain change at a strategic point in the chromatogram constitutes a relatively ineffective approach to method development.

## Startup diagnostic tests

---

The detector runs a series of startup diagnostic tests and posts an error message if any test fails. The startup diagnostic tests are as follows:

- Central processing unit (CPU) test
- Serial communication interface (SCI) test
- Electrically erasable programmable read-only memory (EEPROM) test
- RAM test
- Application program checksum verification
- Lamp test
- Photodiode test
- PMT test
- Optics test/Wavelength verification

## Mobile-phase solvent degassing

---

Mobile-phase difficulties account for at least 70% of all liquid chromatographic problems. Using degassed solvents is important, especially at excitation wavelengths shorter than 220 nm. Bubbles in the flow cell adversely affect detector performance. Degassing provides

- reproducible fluorescent response.
- stable baselines and enhanced sensitivity.
- reproducible retention times for eluting peaks.
- reproducible injection volumes for quantitation.
- stable pump operation.

## Wavelength selection

---

In fluorescence, if the excitation monochromator is set below the UV cutoff of a mobile-phase component, the solvent absorbs some of the available excitation light intensity, which in turn reduces the fluorescence emission response for the sample. For a complete list of UV cutoff ranges for common solvents and common mixed mobile phases, refer to [Appendix C](#).



**Warning:** Using incompatible solvents can cause severe damage to the instrument and injury to the operator.

# 2

## Setting Up the Detector

### Contents

Topic	Page
Before you begin	2-2
Installing the detector	2-3
Plumbing the detector	2-3
Making signal connections	2-5
Connecting other devices	2-23
Connecting to the electricity source	2-36

## Before you begin

---

To install the detector, you must know how to set up and operate laboratory instruments and computer-controlled devices and how to handle solvents.

Before installing the detector, ensure that

- it is not situated under a heating or cooling vent.
- the required components are present.
- none of the shipping containers or unpacked items are damaged.

### Environmental specifications

Attribute	Specification
Operating temperature	4 to 40 °C (39.2 to 104 °F)
Operating humidity	20 to 80%, noncondensing
Shipping and storage temperature	-20 to 80 °C (-4 to 176 °F)
Shipping and storage humidity	0 to 90%, noncondensing

If you discover any damage or discrepancy when you inspect the contents of the cartons, immediately contact the shipping agent and your local Waters representative.

Customers in the USA and Canada should report damage and discrepancies to Waters Technical Service (800 252-4752). Others should phone their local Waters subsidiary or Waters corporate headquarters in Milford, Massachusetts (USA), or they may visit <http://www.waters.com>, and click Offices.

For complete information on reporting shipping damages and submitting claims, see the document *Waters Licenses, Warranties, and Support Services*.

## Installing the detector

---



**Warning:** To avoid injury, Waters recommends that two people lift the 2475 detector.



**Warning:** Risk of fire. To avoid overheating, and to provide clearance for cable connections, make sure there is at least 15.24 cm (6 inches) of clearance at the rear of the detector.

To install the 2475 detector, place it on a level surface to allow proper function of the drip management system (drain tube), to which you can connect to a waste reservoir that diverts solvent leaks from the flow cell.

## Plumbing the detector

---



**Caution:** To prevent flow cell breakage, do not exceed the flow cell's maximum allowable pressure of 1000 kPa (10 bar, 145 psi) and a flow rate of 5 mL/min.

## Connecting columns



**Warning:** To prevent injury, always observe Good Laboratory Practices when you handle solvents, change tubing, or operate the system. Know the physical and chemical properties of the solvents you use. See the Material Safety Data Sheets for the solvents in use.

The plumbing connections to the detector are at the front of the flow cell assembly, on its right-hand side.

### To connect the inlet and outlet tubing:

1. Attach the compression fitting and ferrule (supplied in the startup kit).
2. Connect the inlet tubing to the column outlet, ensure the tubing is seated firmly, and then tighten the compression screw.



**Caution:** Do not put fluid containers on top of the detector without a solvent tray to contain spills.

3. Connect the Teflon<sup>®</sup> tubing to the flow cell outlet tubing, and route it to a waste container.

## Plumbing connections

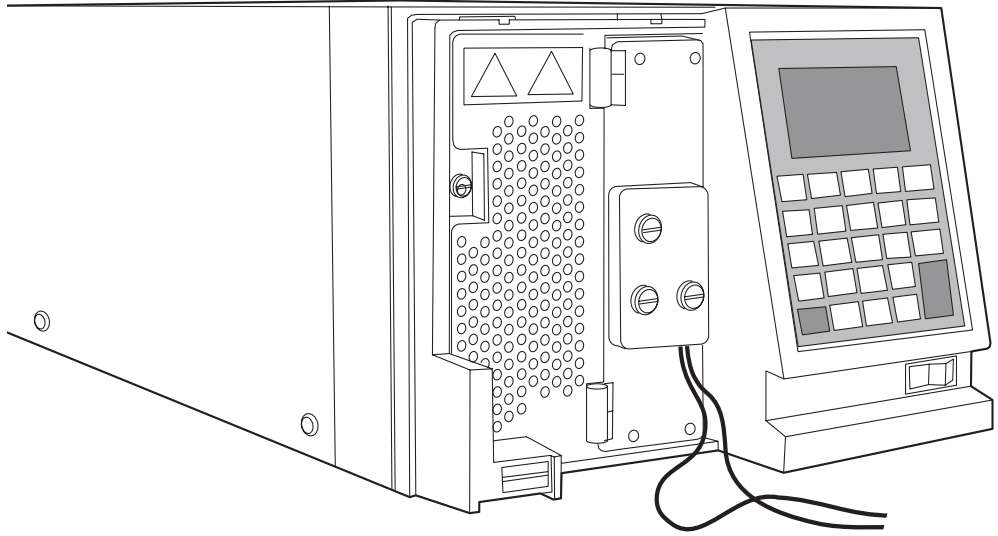

## Assembling fittings

Slide the compression screw over the tubing end. Follow it with the ferrule mounted so that its taper faces the end of the tubing.

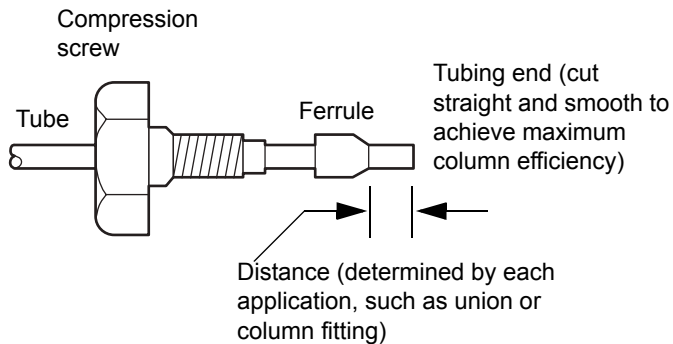



## Making tubing connections

### To make tubing connections:

1. Bottom each tubing end in the column outlet, detector inlet, or detector outlet fitting.
2. Seat each ferrule by tightening the compression screw 1/2-turn past finger-tight.

**Tip:** To ensure accurate verification during installation, be sure to pump fresh, degassed, and filtered 100% water through the flow cell before powering it.

## Making signal connections

---



**Warning:** To avoid electrical shock, power-off and unplug the detector before making signal connections.

**See also:** *Ethernet Instrument Getting Started Guide*.

The following figure shows the rear panel location of the connectors used to operate the detector with external devices.

## 2475 detector rear panel

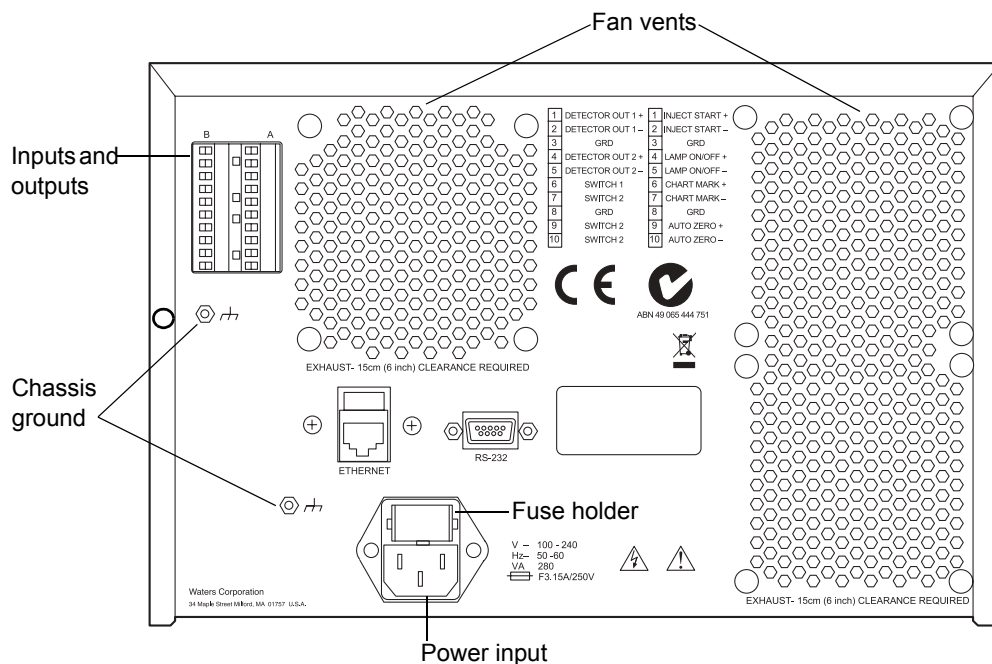

## Component connection overview

**Tip:** Waters recommends you connect the 2475 detector to other system components via an Ethernet connection.

The following table summarizes the signal connections needed to connect the 2475 detector to other HPLC system components.

### Component connector types

Connector type	Component
Ethernet connection	Used to connect to a Waters Empower system using Ethernet.
Analog outputs	<ul style="list-style-type: none"> <li>SAT/IN Module</li> <li>746 Data Module (integrator or data system using the A/D interface)</li> <li>Chart Recorder</li> </ul>

## Component connector types (Continued)

Connector type	Component
Event inputs	<ul style="list-style-type: none"><li>• System controller (used with the Waters Alliance<sup>®</sup> Separations Module and the 600-series solvent delivery system)</li><li>• Waters 700 Series or a non-Waters autosampler</li><li>• Waters or other manual injector</li></ul>
RS-232	Allows remote control and direct data acquisition from an Empower system or a Millennium <sup>32</sup> workstation (version 3.2 and later) in 474 emulation mode.

## Connecting the Ethernet cable

The Waters instrument communicates with the acquisition computer through the dedicated local area network (LAN). At the acquisition computer, the instrument network card provides the communications interface.

You must install the instrument control software driver (ICS) in the acquisition computer so that the computer can control the instrument. (Consult the software installation instructions that accompany the instrument control software for details.)

### Single Waters instrument connection

In a single Waters instrument system configuration, the connection hardware requires only one CAT 5, shielded, Ethernet cross-over cable (startup kit).

## Single Waters instrument connection

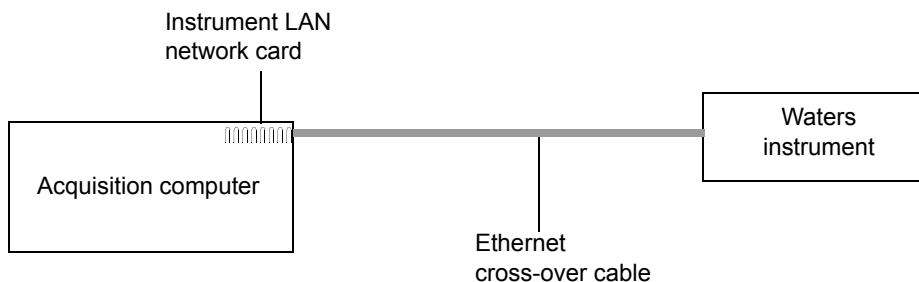

## Multiple Waters instrument connections

In a system configuration that includes many Waters Ethernet instruments, an Ethernet switch communicates between Waters instruments and the acquisition computer.

Connection hardware requires one standard, CAT 5, shielded, Ethernet cable per Waters instrument and a standard, CAT 5, shielded, Ethernet cable between the network switch and the acquisition computer. See the [figure “Multiple Waters ethernet instrument connections” on page 2-9](#).

You must install the Waters instrument control software in the acquisition computer so that the computer can control the Waters instrument. (Consult the software installation instructions that accompany the driver disk.)

## Network installation guidelines

Configurations for multiple Waters instruments use a dedicated local area network (LAN). See the figure, below. The LAN requires a design based on the following guidelines:

- 100-base-T, 100-Mbps, CAT 5, shielded, twisted-pair (STP) cable
- A maximum distance of 100 meters (328 feet)

**Tip:** You must use a network switch with multiple Ethernet instruments. A network hub in place of a network switch is not supported.

## Multiple Waters ethernet instrument connections

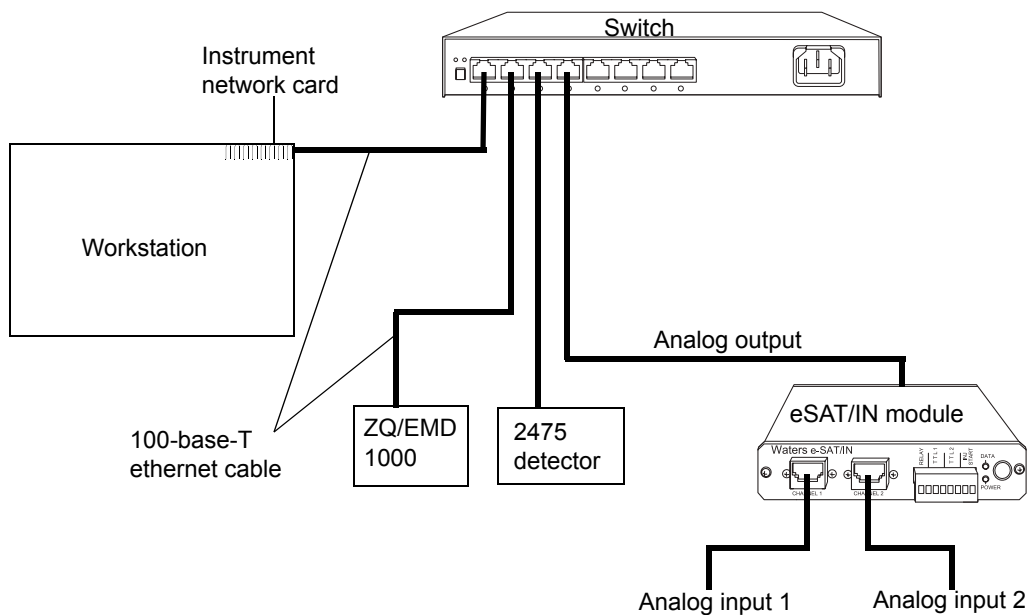

## Making inject-start signal connections

The Ethernet data system or controller used with the 2475 detector must receive an inject-start signal from the autosampler or manual injector to initiate the data collection and time-based programs.

The following table summarizes the inject-start connections for different system configurations

### 2475 detector inject-start connections

Inject-start output source	Inject-start input connection (on the 2475 detector, connector A)
Waters 700 Series Autosampler	Inject Start + / -
Waters Alliance Separations Module	Inject Start
Waters manual injector, or third-party manual injector or autosampler	Inject Start + / -

**Tip:** For pin-out connections to the 2475 detector, see the [figure “I/O signal inputs and outputs” on page 2-11](#).

## Choosing signal connections

**Tip:** Connect the 2475 detector to other HPLC system components through an Ethernet connection.

The rear panel provides two analog connectors and an RS-232 communications port for operating the detector with external devices. You can connect other instruments to the detector through these connectors to enable the following signals:

- **Analog outputs** – Two attenuated, analog-channel outputs, Detector Out 1 and Detector Out 2, support 1-V output to external devices or data systems. For input/output voltage current specifications, see [Appendix B](#). The 1-V output for channel A and channel B is scaled according to the EUFS (emission/energy units full scale) setting for each channel. The detector allows the EUFS to be set individually for the output on each channel. Volts per EU are calculated for the 1-V output as follows:

$$\text{Volts out} = \text{Fluorescence} \times 1 \text{ V/EUFS}$$

For example, an EUFS setting of 10,000 provides a traditional 0.0001 V/EU output. An EUFS setting of 100,000 provides a 0.00001 V/EU output, which supports chromatography above 10,000 EU.

- **Chassis ground stud** – Connect the shield from analog connections here.
- **Switched outputs** – You can program two switch contact closures to turn on, off, toggle, pulse once for a defined duration, or pulse repetitively for a specified period of time.
- **Event inputs** – Four general-purpose TTL contact closures on the detector’s A (Inputs) terminal support the following functions (see the [table titled “Primary and secondary function \(method\) parameters” on page 3-21](#)):
  - Remote or inject start
  - Lamp on/off
  - Chart mark input
  - Auto Zero

- **RS-232 Interface** – The RS-232 connection allows remote control and direct data acquisition from an Empower system or a Millennium<sup>32</sup> workstation (version 3.2 and later) in 474 emulation mode.

## Making I/O signal connections

The rear panel includes two removable connectors that hold the pins for the I/O signals (see the following figure). These connectors, A and B, are keyed so that you can insert them only one way.

### I/O signal inputs and outputs

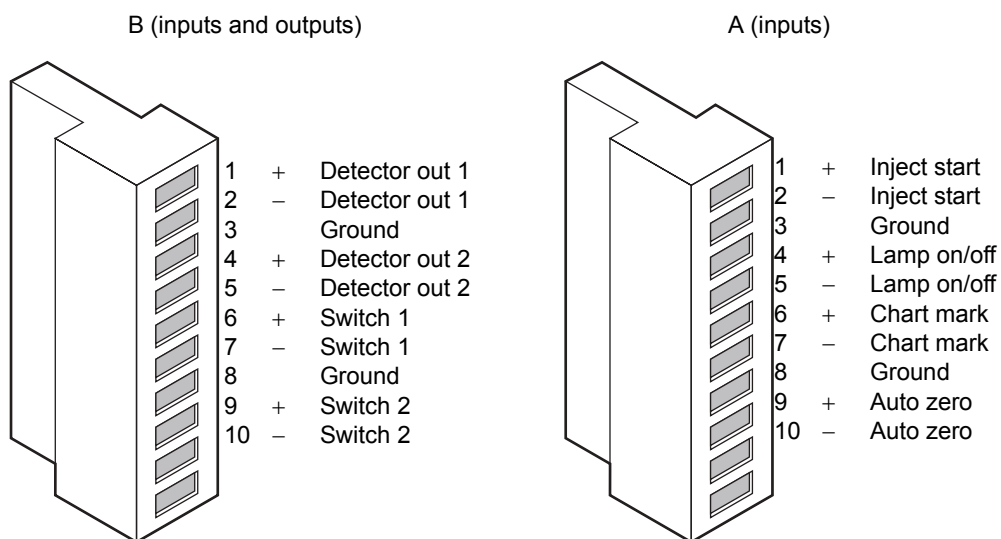

The following table describes each signal available on the I/O connectors. See [Appendix B](#) for the signal's electrical specifications

### I/O signals for the detector

Signal	Description
Inject Start <sup>1</sup>	TTL contact closure. Configurable input to initiate sequencing of time-programmed events. Defines the start of a run (typically an injection) and resets and starts the runtime clock at 0.00 minutes. Initial conditions apply immediately.

## I/O signals for the detector (Continued)

Signal	Description
Lamp On/Off <sup>1</sup>	Configurable input to allow an external device to turn the xenon lamp off and on.
Chart Mark <sup>1</sup>	Configurable input to add a chart mark (at 10% of full scale) to either or both analog output channels (Detector Out 1 and Detector Out 2).
Auto Zero <sup>1</sup>	Configurable input to Auto Zero both channels (Detector Out 1 and Detector Out 2).
Detector Out 1 <sup>2</sup>	1-V full-scale analog output signal of channel A (scaled to the current EUFS setting).
Detector Out 2 <sup>2</sup>	1-V full-scale analog output signal of channel B (scaled to the current EUFS setting).
Switch 1 (2)	Can be controlled by threshold and timed events.
Switch 2 (2)	Can be controlled by threshold and timed events.

1. Inject start, chart mark, Auto Zero, and lamp inputs are configurable. Use the second Configuration screen and set the appropriate parameter to Low (see [page 3-25](#)).

2. See [page 2-10](#).

## Signal connections

Refer to the signal connection location shown on the silk-screened label on the rear panel of each instrument.

**Tip:** To meet the regulatory requirements of immunity from external electrical disturbances, you must install connection covers over the signal connectors.



## To make signal connections:

1. Attach the positive and negative leads of the signal cable to the connector.

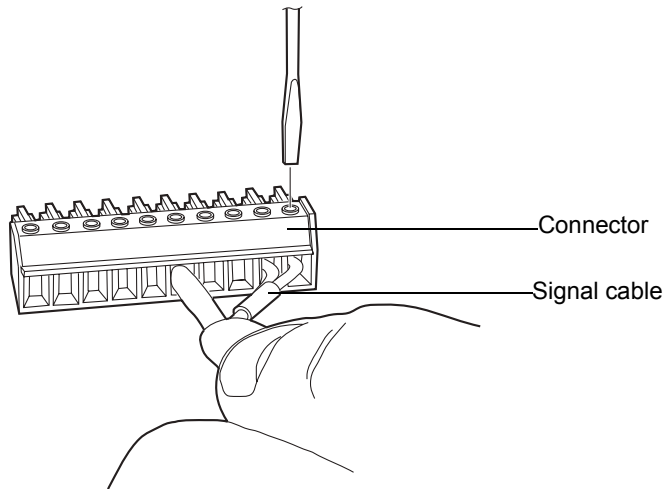

2. Slide the clamp (with the bend facing down) into the protective shield.
3. Insert the clamp and shield (with the bend facing down) into the connection cover and loosely tighten with one self-tapping screw.

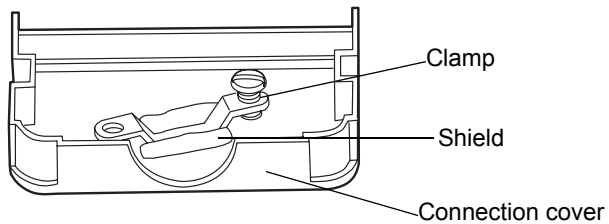

4. Insert the connector with the signal cable into the connection cover, position the clamp over the cable leads, and then tighten the clamp into place with the second self-tapping screw.

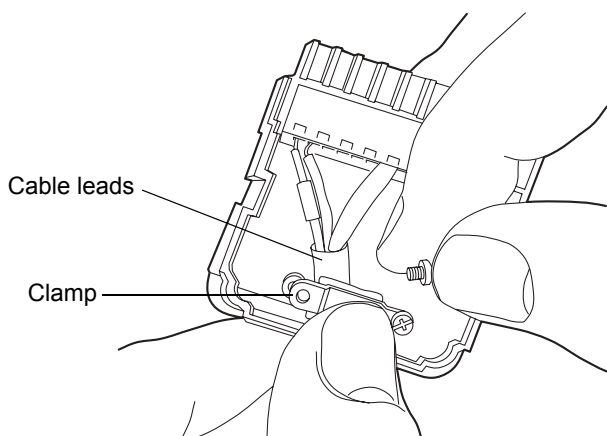

5. Place the second connection cover over the first cover and snap it into place.

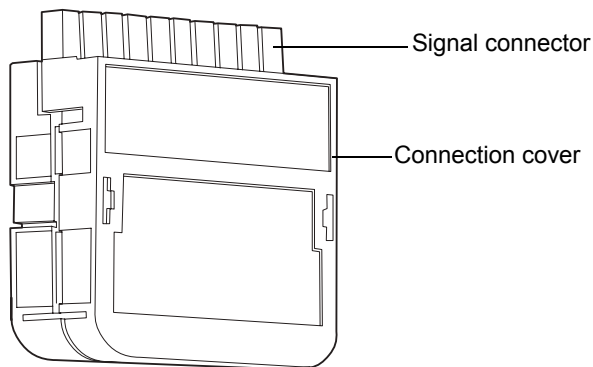

## Connecting an Alliance separations module

You can connect an Alliance separations module to the detector to perform the following functions (when the detector is not under the control of Empower or Millennium<sup>32</sup> software):

- Generate an Auto Zero on injection
- Generate a chart mark on injection
- Start a method

- Turn the lamp on and off

## Generating an auto zero on inject

To auto zero the detector at the start of an injection from an Alliance separations module:

1. Make the connections shown in the following table and figure.

### Connections for generating an auto zero on inject

Alliance separations module (B inputs and outputs)	2475 detector (A inputs)
Pin 1 Inject Start	Pin 9 Auto Zero +
Pin 2 Inject Start	Pin 10 Auto Zero –

2. Configure the auto-zero signal at the detector's front panel. The default auto-zero signal is Low (see [page 3-25](#)).

### Connections for auto zero on injection

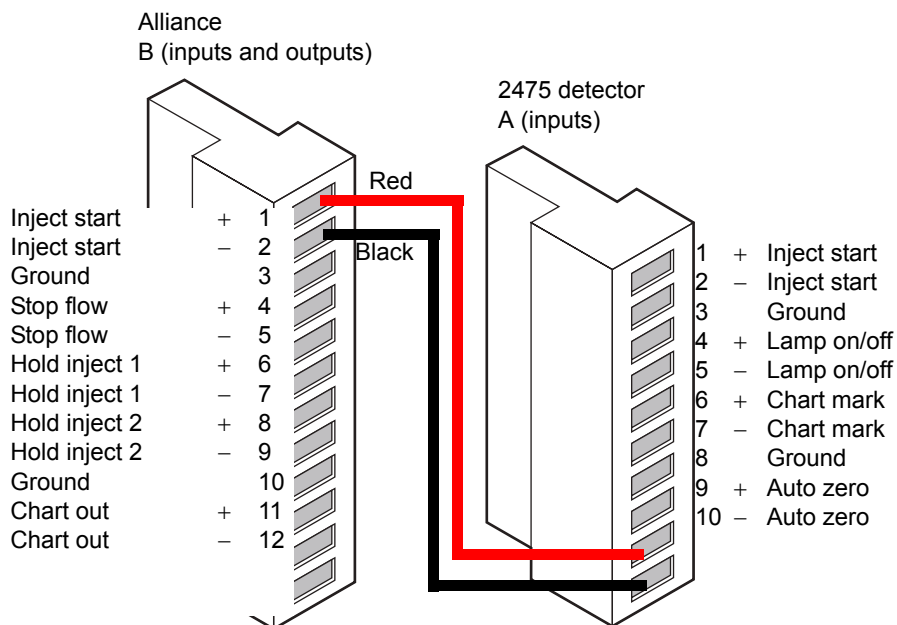

## Generating a chart mark on inject

To generate a chart mark at the start of an injection from an Alliance separations module:

1. Make the connections shown in the following table and figure.

### Connections for generating a chart mark on inject

Alliance separations module (B inputs and outputs)	2475 detector (A inputs)
Pin 1 Inject Start	Pin 6 Chart Mark +
Pin 2 Inject Start	Pin 7 Chart Mark –

2. Configure the chart mark signal at the detector's front panel. The default chart mark signal is Low (see [page 3-25](#)).

### Connections for chart mark on injection

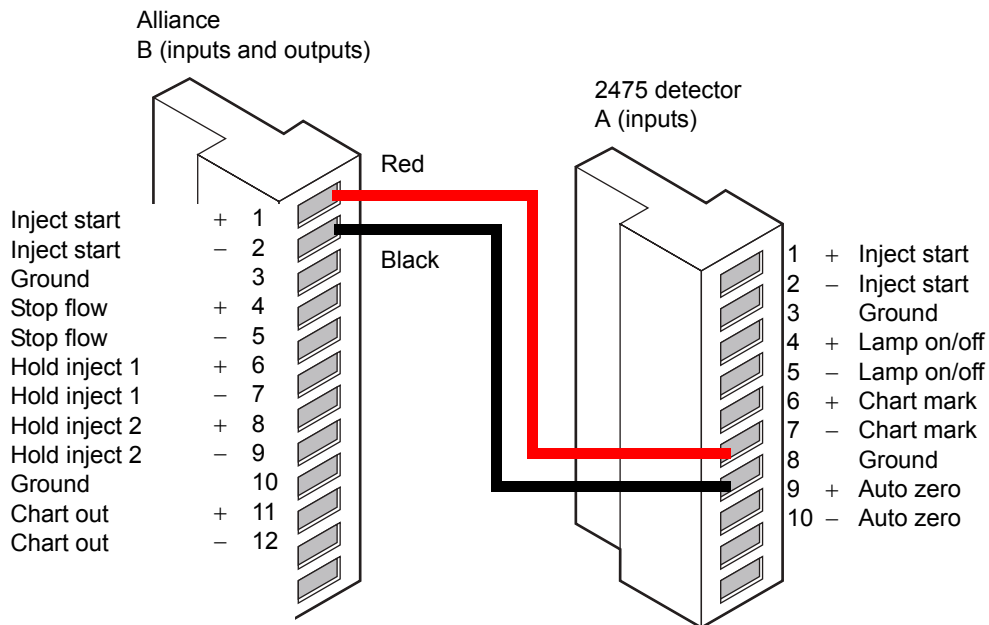

## Starting a method

To enable the detector to start a method when an injection from an Alliance separations module begins, make the connections shown in the following table and figure.

### Connections for starting a method

Alliance separations module (B inputs and outputs)	2475 detector (A inputs)
Pin 1 Inject Start	Pin 1 Inject Start +
Pin 2 Inject Start	Pin 2 Inject Start -

### Connections for starting a method on injection

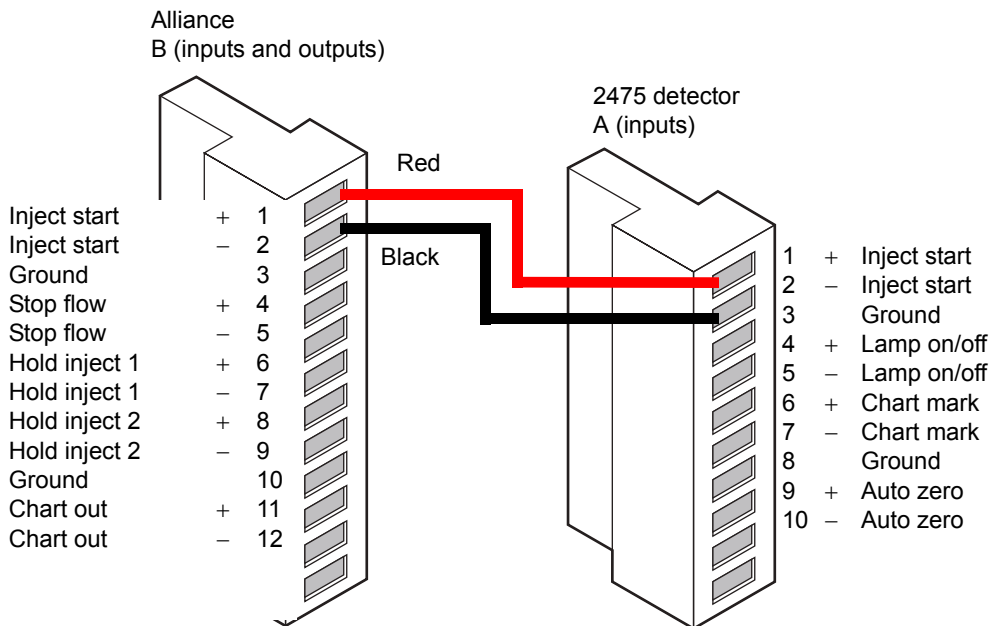

## Turning the lamp on or off

### To turn the lamp on or off from an Alliance separations module:

1. Configure the lamp on/off signal at the detector's front panel by changing the default lamp configuration parameter from Ignore to High or Low (see [page 3-25](#)).

2. Make the connections shown in the following table and figure.

### Connections for turning the detector lamp on or off

Alliance separations module (A Outputs)	2475 detector (A Inputs)
Pin 1 Switch 1	Pin 4 Lamp On/Off +
Pin 2 Switch 1	Pin 5 Lamp On/Off –

### Connections for turning the lamp on or off

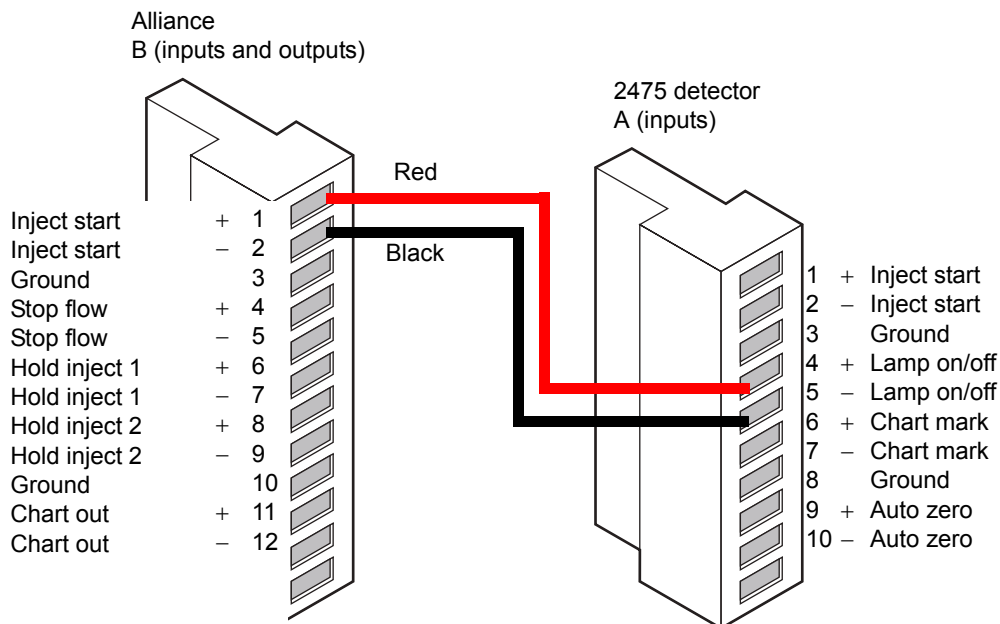

## Connecting RS-232 devices

**Tip:** The RS-232 interface connector is used when the detector is in 474 Emulation mode.

The rear panel includes one RS-232 interface connector for digital signal communications. Use it to connect RS-232 devices, such as an RS-232 communications port in an Empower system or Millennium<sup>32</sup> chromatography

workstation, to the detector (see the following figure). The RS-232 connector mates with a standard RS-232 cable.



**Caution:**

- To avoid possible damage to components, shut down all instruments already on the RS-232 control bus before you connect an RS-232 interface cable to an additional instrument.
- The maximum total cable length between RS-232 devices in a system is 65 feet (20 meters). The maximum recommended cable length between two RS-232 devices is 10 feet (3 meters). Longer total cable lengths can cause intermittent RS-232 communication failures.

**Tip:** With the RS-232 cable connected, the detector operates in remote mode. When you connect to an Empower system or Millennium<sup>32</sup> Chromatography Manager (version 3.2 and later), you must enable the Emulate 474 configuration option for multichannel operation.

### IEEE-488 and RS-232 connections in an Empower system

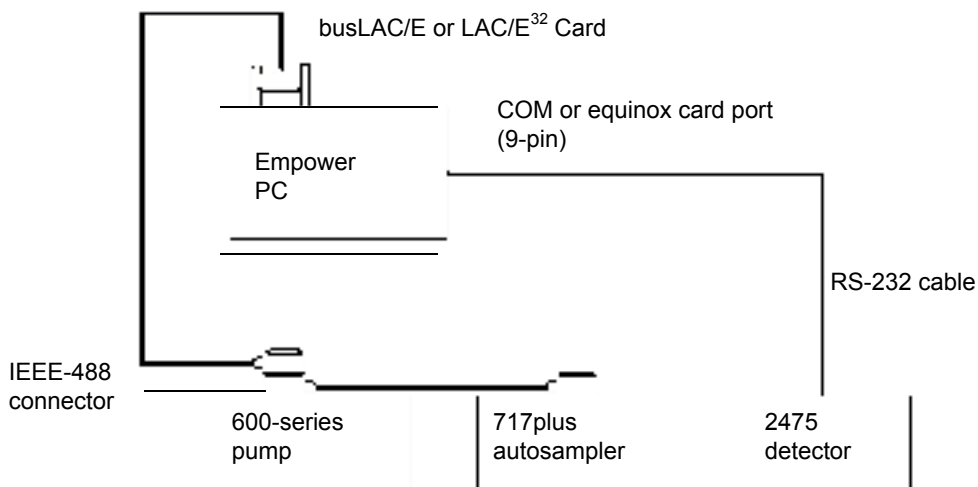

**Tip:** RS-232 communication does not support multichannel mode.

**Tip:** When connecting the detector to a Waters data system, all detector parameters not configurable by the data system in use defer to local control.

### To connect an RS-232 device such as a Waters data system to the detector:

1. Connect the single receptacle end of the RS-232 cable (supplied with the detector) to an RS-232 device. Such a device may be an RS-232 communications port or Equinox card in an Empower system or a Millennium<sup>32</sup> chromatography workstation.
2. Connect the other end of the cable to the RS-232 connector on the detector's rear panel.
3. Ensure all RS-232 cable screws are fastened tightly.
4. Ensure all input/output connections are correct (see the [figure "IEEE-488 and RS-232 connections in an Empower system" on page 2-19](#)).
5. Configure the detector for RS-232 communication, and operate it in remote mode, as described on [page 3-25](#).
6. Connect an inject-start cable (see the [figure "Connections for starting a method on injection" on page 2-17](#)).

## Connecting Ethernet devices

The detector can be controlled using Ethernet communications when Empower software build 2154 or build 1154 with Instrument Support Service Pack 2 (ISSP 2) and the 2475 instrument control software (ICS) are installed.

### Connecting the Ethernet cable

The Waters instrument communicates with the acquisition computer through the dedicated local area network (LAN). At the acquisition computer, the instrument network card provides the communication interface.

You must install the Waters instrument software driver in the acquisition computer before the computer can control the Waters instrument. See the software installation instructions that accompany the instrument control software.

### Single Waters instrument connection

In a single Waters instrument system configuration, the connection hardware requires only one standard, shielded Ethernet cross-over cable (startup kit). Refer to the following figure.



## Single Waters instrument connection

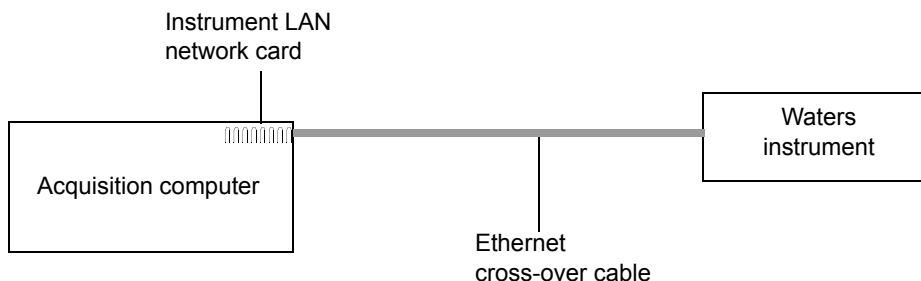

## Multiple Waters instrument connections

In a system configuration with many Waters Ethernet instruments, an Ethernet switch is required to multiplex the communication between Waters instruments and the acquisition computer.

Connection hardware requires one standard 100-base-T Ethernet cable per Waters instrument, and a standard 100-base-T Ethernet cable to connect between the network switch and the acquisition computer. Refer to the [figure “Multiple Waters ethernet instrument connections” on page 2-22](#).

You must install the Waters instrument control software in the acquisition computer before the computer can control the Waters instrument. See the software installation instructions that accompany the software instrument driver disk.

## Network installation guidelines

Configurations for multiple Waters instruments use a LAN (see the following figure). This dedicated LAN requires a design based on the following guidelines:

- 100-base-T, 100-Mbps shielded twisted-pair (STP) cable
- A maximum distance of 100 meters (328 feet)

**Tip:** You must use a network switch if you are using multiple Ethernet instruments. Use of a network hub in place of a network switch is not supported.

## Multiple Waters ethernet instrument connections

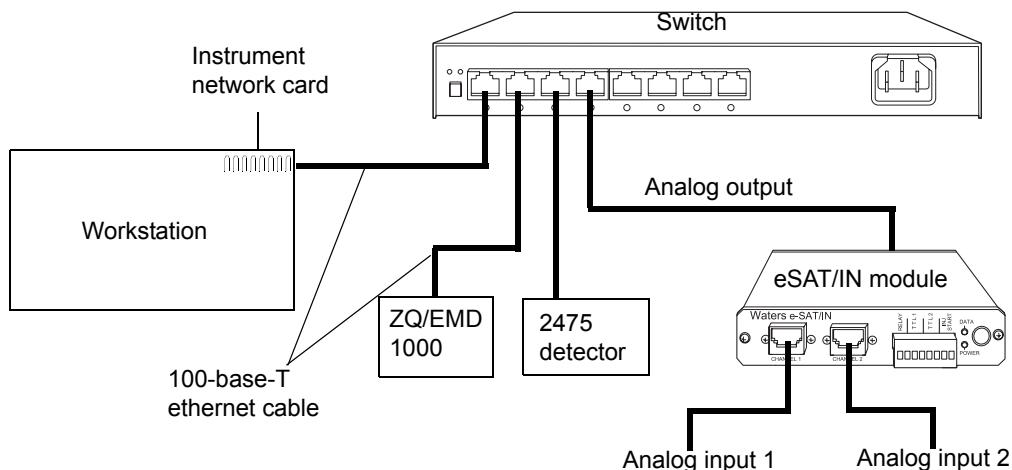

## Making inject-start signal connections

When you are using an Ethernet data system with the 2475 detector, the data system or controller must receive an inject-start signal from the autosampler or manual injector to initiate the data collection and time-based programs.

The following table summarizes the inject-start connections for different system configurations.

### 2475 detector inject-start connections

Inject-start output source	Inject-start input connection (on the 2475 detector, connector A)
Waters 700 Series Autosampler	Inject Start + / -
Waters Alliance Separations Module	Inject Start
Waters manual injector, or third-party manual injector or autosampler	Inject Start + / -

**Tip:** For pin-out connections to the 2475 detector, see the [figure “I/O signal inputs and outputs” on page 2-11](#).

## Connecting other devices

---

You can connect many devices to the detector, including these:

- Empower PC using the bus SAT/IN™ module
- Millennium<sup>32</sup> chromatography workstation using the bus SAT/IN module
- Waters 746 Data Module
- Chart recorder
- Waters 600-series pump
- Waters 717plus Autosampler
- Waters Fraction Collector II or III

### Required materials

To connect cables to the terminals on the detector's rear panel, you need the following tools:

- Small flat-blade screwdriver (startup kit)
- Electrical insulation stripping tool

### Connecting cables

**To connect the cables from other HPLC system devices to the A and B terminals on the detector's rear panel:**

1. Remove terminal A or B (see the [figure "I/O signal inputs and outputs" on page 2-11](#)).
2. Unscrew the connecting pin terminal.
3. Using the stripping tool, strip the wire about 1/8-inch from the end.
4. Insert the stripped wire into the appropriate connector.
5. Tighten the screw until the wire is held securely in place.
6. Reinsert the terminal.
7. Press the terminal firmly to ensure that it is inserted fully.

## Connecting a data system using a Bus SAT/IN module

You can acquire data from the detector with the Empower system or the Millennium<sup>32</sup> chromatography workstation using the Bus SAT/IN module instead of the RS-232 bus (see [page 2-18](#)). This method requires connections between the detector and a satellite interface (SAT/IN) module.

The bus SAT/IN module translates analog signals from the detector into digital form. It then transmits them to the busLAC/E™ or LAC/E<sup>32</sup> card installed in an Empower system or Millennium<sup>32</sup> chromatography workstation.

### Bus SAT/IN module (front panel)

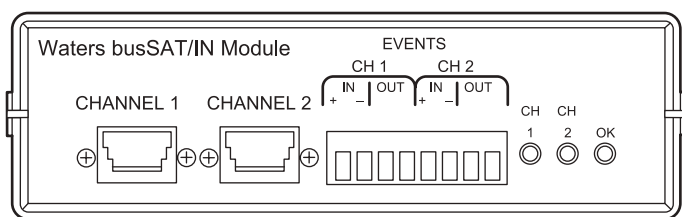

### To connect an Empower system or Millennium<sup>32</sup> chromatography workstation to the detector:

1. Connect the Bus SAT/IN module to the busLAC/E or LAC/E<sup>32</sup> card in an Empower system or Millennium<sup>32</sup> computer according to the instructions in the *Waters Bus SAT/IN Module Installation Guide*.



#### Caution:

- Do not turn start the Bus SAT/IN module until you perform all procedures in the *Waters Bus SAT/IN Module Installation Guide*. Improper startup can damage the unit and void the warranty.
  - The Bus SAT/IN module does not have a power switch. To prevent damage to the module, always disconnect the power cord at the wall outlet or the power supply before attaching or removing the power connection to the module.
2. Connect the Bus SAT/IN module to the B (Inputs and Outputs) terminal on the detector's rear panel.

- a. Using the electrical insulation stripping tool, strip about 1/8 inch from one end of the Bus SAT/IN connector, exposing the white and black wires.
  - b. For channel A (see the [figure “Connecting the Bus SAT/IN module channel 1 to the detector”](#) on page 2-26 and the [figure “I/O signal inputs and outputs”](#) on page 2-11):  
Connect the white wire to pin 1 on B (Detector Out 1 + [+1 V]).  
Connect the black wire to pin 2 on B (Detector Out 1 – [-1 V]).
  - c. For channel B (see the [figure “Connecting the Bus SAT/IN module channel 2 to the detector”](#) on page 2-26 and the [figure “I/O signal inputs and outputs”](#) on page 2-11):  
Connect the white wire to pin 4 on B (Detector Out 2 + [+1 V]).  
Connect the black wire to pin 5 on B (Detector Out 2 – [-1 V]).
  - d. Connect the other end of the cable to the channel 1 or channel 2 connector on the front panel of the Bus SAT/IN module.
3. Configure the serial port for the Bus SAT/IN module as described in the *Empower Software Getting Started Guide* or the *Millennium<sup>32</sup> Software Getting Started Guide*.



**Caution:** To minimize the chance of creating a ground loop that can adversely affect measurement, connect the shield of the cable to the chassis ground at one end only.

## Connecting the Bus SAT/IN module channel 1 to the detector

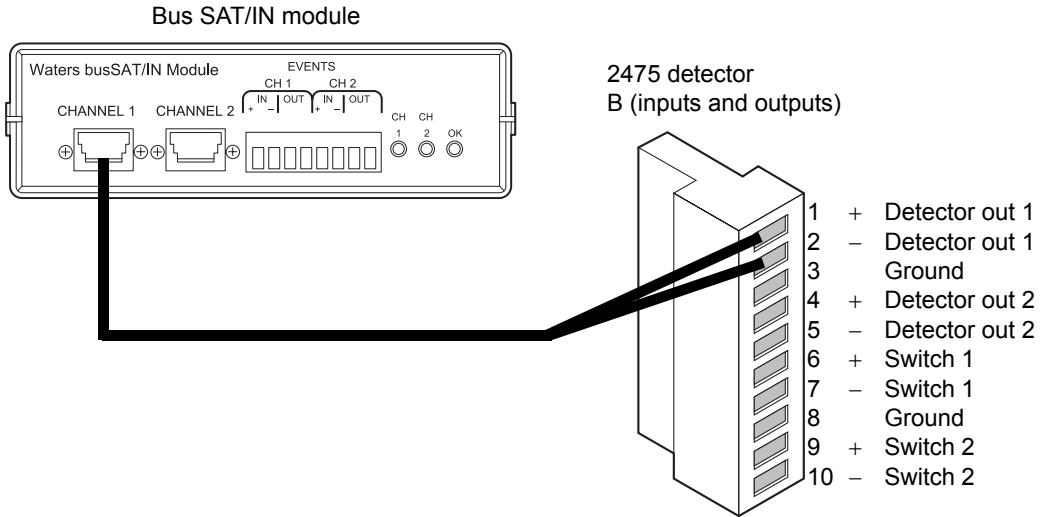

## Connecting the Bus SAT/IN module channel 2 to the detector

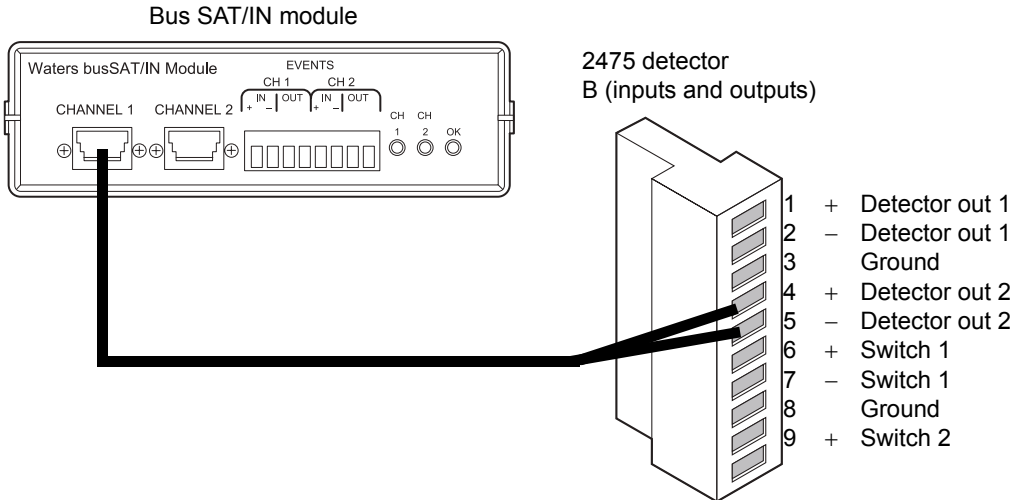

## Detector connections to the Bus SAT/IN module

Bus SAT/IN connector	2475 detector (B outputs)
Channel 1 or 2	Pin 1 Detector Out 1 + (white)
	Pin 2 Detector Out 1 – (black)
Channel 1 or 2	Pin 4 Detector Out 2 + (white)
	Pin 5 Detector Out 2 – (black)

## Connecting a 746 data module

You can connect a Waters 746 data module to the detector using the analog output connector on the detector's rear panel. The analog connector provides 1 V output, which is scaled to the EUFS sensitivity setting and the voltage offset setting.

**Tip:** To prevent oversaturation of the signal from the detector to the data module, do not exceed the input voltage rating of the data module.

To send the analog output signal from the detector to the data module, use the cable provided in the detector's startup kit to make the connections shown in the following table and figure.

### Detector inputs and 746 terminals

746 terminals	2475 detector (B inputs and outputs)
+	Pin 1 Detector Out 1 + (red)
–	Pin 2 Detector Out 1 – (black)
+	Pin 4 Detector Out 2 + (red)
–	Pin 5 Detector Out 2 – (black)

**Tip:** To minimize the chance of creating a ground loop that can adversely affect measurement, connect the shield of the cable to the chassis ground at one end only.

## Connecting a 746 data module to the detector

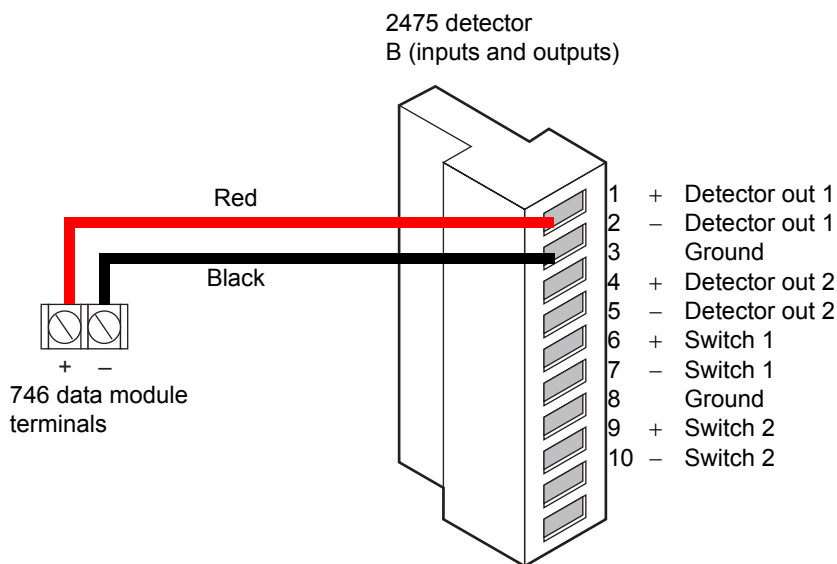

## Connecting a chart recorder

### Recorder signal

The A and B terminals on the detector's rear panel provide 1-V analog output signals that you can send to a chart recorder. To send a 1-V signal from the detector to a chart recorder, use the cable in the startup kit to make the connections in the following table and figure.

### Detector inputs and chart recorder terminals

Chart recorder terminals	2475 detector (B inputs and outputs)
+	Pin 1 Detector Out 1 + (1 V)
-	Pin 2 Detector Out 1 - (1 V)
+	Pin 4 Detector Out 2 + (1 V)
-	Pin 5 Detector Out 2 - (GND)

**Tip:** To minimize the chance of creating a ground loop that can adversely affect measurement, connect the shield of the cable to the chassis ground at one end only.



## Connecting a chart recorder to the detector

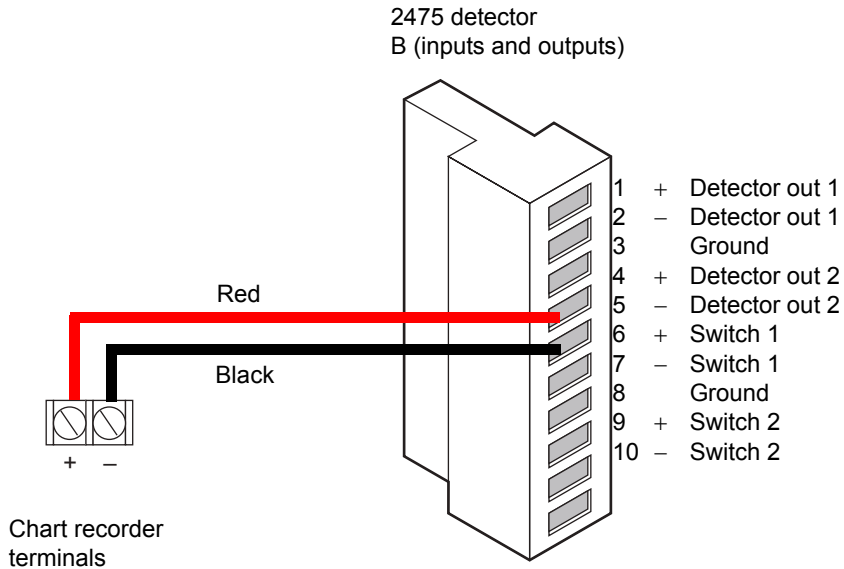

## Chart marks

You can also generate a chart mark from the detector's front panel whenever you perform these actions:

- Press Chart Mark on the detector's keypad.
- You program a timed event to generate a chart mark.
- A chart mark signal is generated at the chart mark inputs on the analog connector.

## Connecting a 600-series pump

To connect a 600-series pump:

1. Place the detector on a level surface.
2. Make the plumbing connections described on [page 2-3](#).

## Lamp on/off connections

### To make lamp on/off connections:

1. Make the lamp on/off connections shown in the following table and figure with a signal cable.
2. Configure the lamp on/off signal at the detector's front panel by changing the default from Ignore to High or Low (see [page 3-25](#)).
3. Using the signal cable, make the lamp on/off connections from the pump controller to the detector shown in the following table and figure.

### Detector inputs and 600-series pump terminal connections

600-series pump terminal	2475 detector (A inputs)
S1, S2, S3, or S4	Pin 4 Lamp On/Off +
GND (any one of four)	Pin 5 Lamp On/Off –

### Lamp on/off connections for the 600-series pump

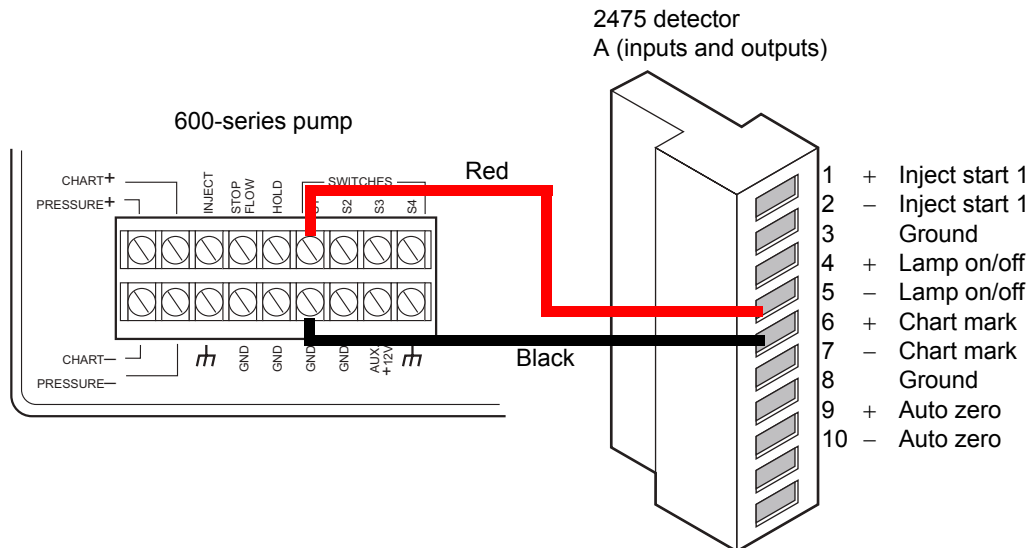

## Auto-zero connections

### To make auto-zero connections:

1. Make the connections shown in the following table and figure with a signal cable.
2. Program the pump to provide a pulse output on the applicable switch (S1, S2, or S4) at the beginning of each run (see the *Waters 600E Multisolvent Delivery System User's Guide*).

### Auto-zero connections for the 600-series pump

600-series pump terminal	2475 detector (A inputs)
S1, S2, S3, or S4	Pin 9 Auto Zero +
GND (any one of four)	Pin 10 Auto Zero –

### Auto-zero connections for the 600-series pump

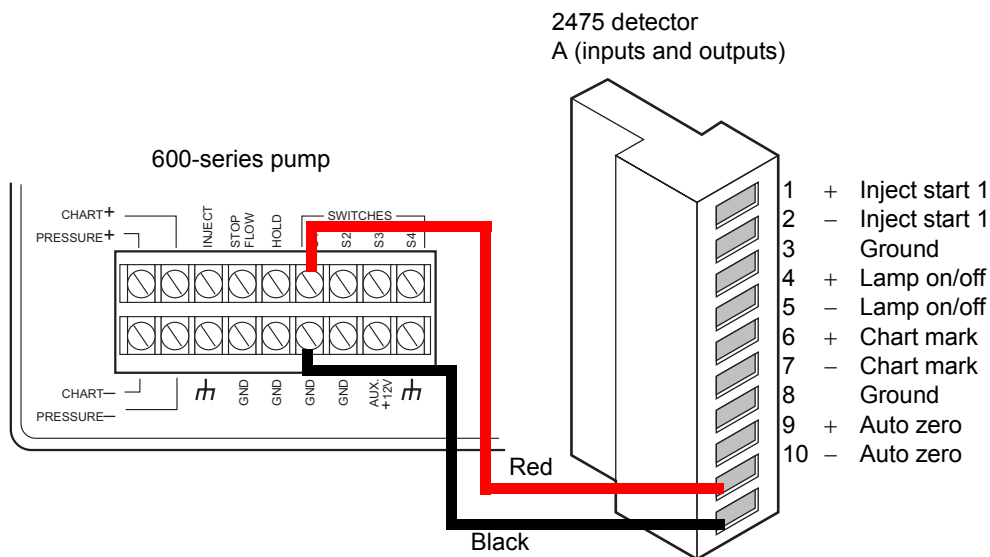

## Chart-mark connections

### To make chart-mark connections:

1. Make the connections shown in the following table and figure using a signal cable.

2. Program the pump to provide a pulse output on the selected switch at the beginning of each run. See the *Waters 600E Multisolvant Delivery System User's Guide*.

### Chart-mark connections for the 600-series pump

600-series pump terminal	2475 detector (A inputs)
S1, S2, S3, or S4	Pin 6 Chart Mark +
GND (any one of four)	Pin 7 Chart Mark –

### Chart-mark connections for the 600-series pump

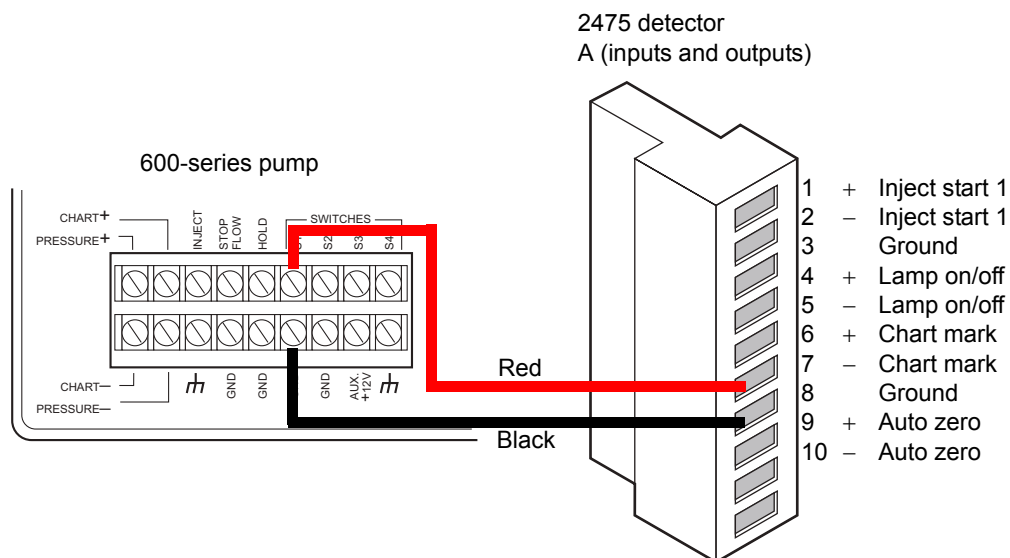

### Inject-start connections

When the detector is connected to an Empower system or Millennium<sup>32</sup> chromatography workstation, the inject-start connections allow it to initiate data acquisition.

#### To make inject-start connections:

1. Make the connections shown in the following table and figure with a signal cable.

2. Program the pump to provide a pulse output on the selected switch at the beginning of each run (see the *Waters 600E Multisolvent Delivery System User's Guide*).

### Inject-start connections for the 600-series pump

600-series pump terminal	2475 detector (A inputs)
S1, S2, S3, S4 <sup>1</sup> , or inject	Pin 1 Inject Start +
GND (any one of four)	Pin 2 Inject Start -

1. You may also connect the pump's Inject terminal to pin 1, Inject Start +, on the detector and the pump's Inject Ground terminal to the detector's pin 2, Inject Start -.

### Inject-start connections for the 600-series pump

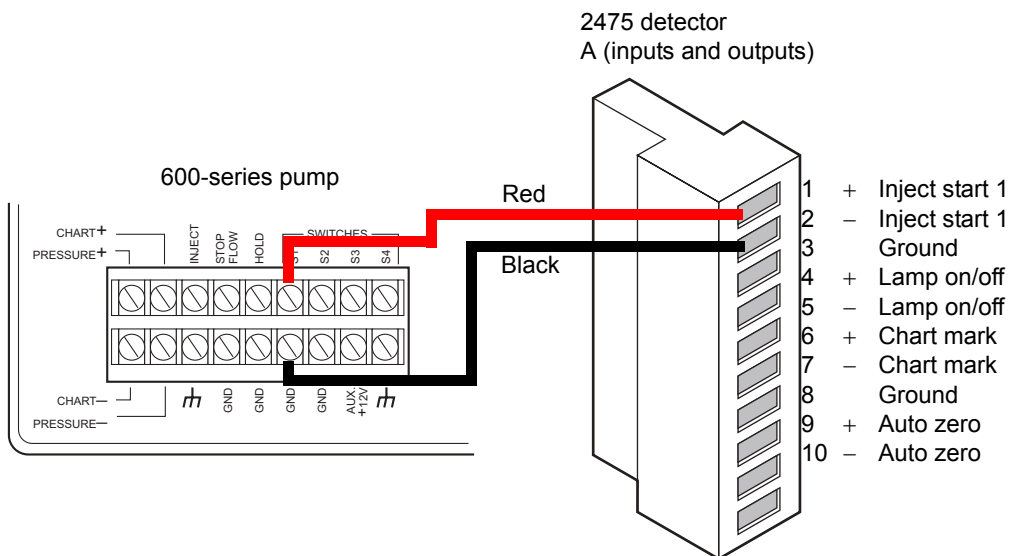

## Connecting a 717plus Autosampler

The Waters 717plus Autosampler signals the start of an injection through a contact closure signal on its inject-start terminals. You can use this contact closure signal to command the detector to auto zero at the start of an injection.

## Auto-zero connections

To auto zero the detector at the start of an injection, make the connections in shown in the following table and figure.

### Auto-zero connections for the 717plus autosampler

717plus autosampler terminal	2475 detector (A inputs)
Inject Start + (any one of many paired with -)	Pin 9 Auto Zero +
Inject Start - (any one of many paired with +)	Pin 10 Auto Zero -

The following figure illustrates the connections between the detector and autosampler. Use any available pair of inject-start terminals on the autosampler.

### Auto-zero connections for the 717plus autosampler

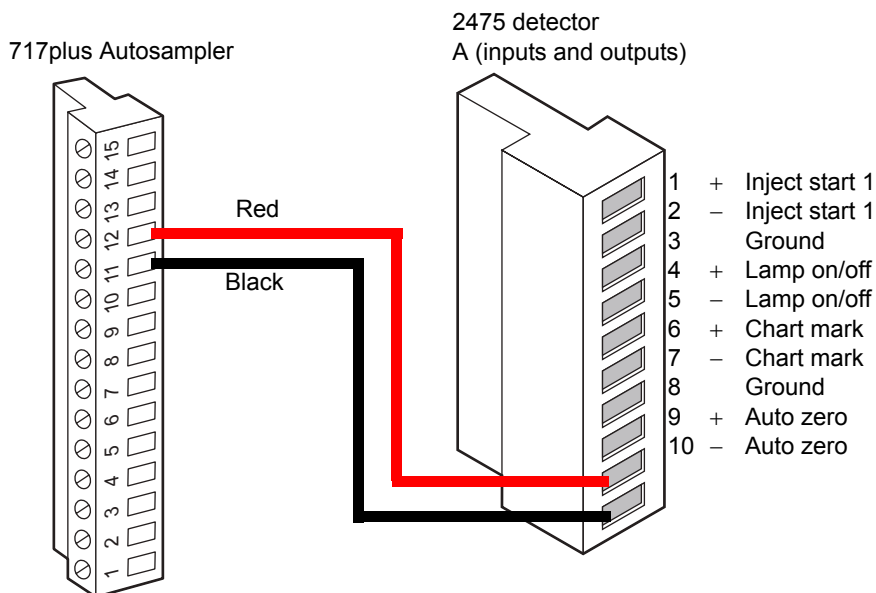

## Inject-start connections

To program the start of an active method, connect the autosampler's inject-start terminals to the detector's inject-start inputs (see the following table and figure).

### Inject-start connections for the 717plus Autosampler

717plus Autosampler terminal	2475 detector (A inputs)
Inject Start + (any one of many paired with +)	Pin 1 Inject Start +
Inject Start - (any one of many paired with -)	Pin 2 Inject Start -

The following figure illustrates the connections between the detector and the autosampler. Use any available pair of inject-start terminals on the autosampler.

### Inject-start connections for the 717plus Autosampler

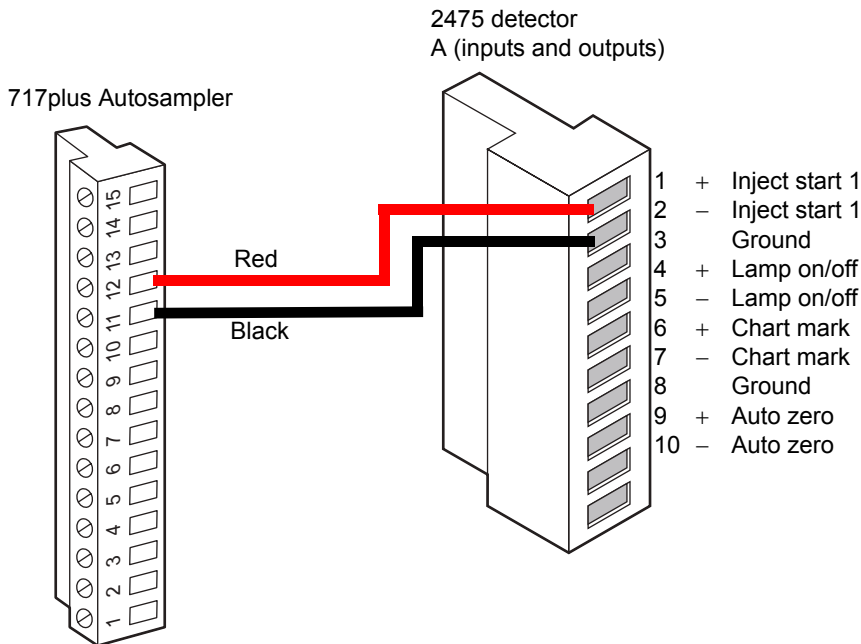

## Connecting to the electricity source

---

The 2475 detector requires a separate, grounded electricity source. The ground connection in the electrical outlet must be common and connected near the system.





**Warning:** To avoid electrical shock:

- Use power cord SVT-type in the United States and HAR-type or better in Europe. For other countries, contact your local Waters distributor.
- Power-off and unplug the detector before performing any maintenance operation on the instrument.
- Connect the detector to a common ground.

### To connect to the electricity source:

**Tip:** Use a line conditioner or an uninterruptible power supply (UPS) for optimum long-term input voltage stability.

1. Place the Off/On () switch in the Off () position.
2. Connect the female end of the power cord to the receptacle on the rear panel of the detector.
3. Connect the male end of the power cord to a suitable wall outlet.

**Tip:** Do not turn the detector on at this time.



# 3

## Using the Detector

After you install the detector, you must set it up and operate it as a standalone instrument or as part of a data system.

- As a standalone instrument – You can use the detector as a standalone detector with a system such as the Waters Alliance system or with any pump, injector, chart recorder, or integrator. You can program the detector's front panel unless it is controlled by a data system such as Waters Empower or Millennium<sup>32</sup> software.
- As part of an Empower system – You can configure the detector for use in an Empower system. To do so, follow the instructions in the Empower Online Help to set parameters for controlling the detector.
- As part of a Millennium<sup>32</sup> chromatography workstation – You can configure the detector for use with a Millennium<sup>32</sup> chromatography workstation, version 3.2 and later. To do so, follow the instructions in the *Millennium<sup>32</sup> Online Help* to set parameters for controlling the detector. In Millennium<sup>32</sup> Chromatography Manager, version 3.2 and later, the detector is configured in 474 Emulation mode and recognized by Millennium as a 474 detector.

### Contents:

Topic	Page
Starting the detector	3-2
Using the operator interface	3-4
Preparing to start a run	3-18
Operating the detector	3-28
Programming methods and events	3-43
Scanning spectra	3-52
Managing results	3-65
Conserving lamp life	3-67
Shutting down the detector	3-70

## Starting the detector

---



### **Warning:**

- Always observe Good Laboratory Practices when you use this equipment and when you work with solvents and test solutions. Know the chemical and physical properties of the solvents and test solutions you use. See the Material Safety Data Sheet for each solvent and test solution in use.
- Using incompatible solvents can cause severe damage to the instrument and injury to the operator. Refer to Appendix C for more information.



**Warning:** Explosion hazard. The flash point is the lowest temperature at which a flame can propagate through the vapor of a combustible material to its liquid surface. A chemical's flash point is determined by the vapor pressure of the liquid. Only when a sufficiently high concentration is reached can a solvent vapor support combustion.

## Initializing the detector

Before you start the detector, be sure the power cord is properly installed at the detector's rear panel and plugged into the power source.

To start the detector, press the on/off switch on its front, lower-right-hand corner (see the [figure "Waters 2475 Multi  \$\lambda\$  Fluorescence Detector" on page 1-7](#)).

The detector beeps three times, displays the message "Booting System... Please Wait (Service Keypad Inputs Accessible for 6 sec.)," and runs a series of startup diagnostic tests.

**Tip:** Service keypad inputs are coded for use only by Waters service engineers for troubleshooting purposes.

The detector displays the following messages:

1. Initializing grating
2. Initializing system
3. Lighting lamp
4. Warmup time left (counts down from five minutes)

## 2475 detector startup screen

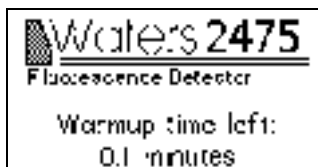

5. Homing optical filter
6. Searching for Zero Order Peaks
7. Finding erbium calibration peaks
8. Restoring last setup

When initialization is complete, the 2475 detector displays the Fluorescence home screen. See [page 3-9](#) and [page 3-16](#) for more information.

## Fluorescence home screen

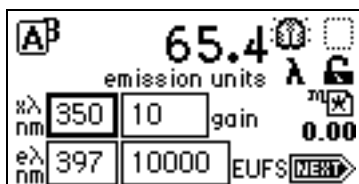

**Tip:** For normal use, allow the detector to warm at least 60 minutes before operating.

## Startup failure

If one or more of the internal startup checks fails, the detector beeps and displays an error message. For serious errors, the detector displays the word “Error” in brackets (<Error>) in place of the runtime emission units on the home screen.

“[Startup error messages](#)” on [page 5-2](#) lists startup diagnostics failures, error messages, and recommended recovery actions. The [table titled “Error messages preventing operation”](#) on [page 5-4](#) displays operational error messages and suggested corrective actions. “[Hardware troubleshooting](#)” on [page 5-21](#) displays hardware-related causes of startup diagnostics failure and corrective actions.

## Idle mode

When the detector is successfully started, it defaults to idle mode (see the [figure “2475 detector idle mode screen” on page 3-4](#)). When it is not performing any function requiring the shutter to be open (local methods, scans, noise test, and so on), the shutter is closed, and the detector remains in idle mode with the lamp lit. The Closed Shutter limits unnecessary UV light from reaching the detector’s optics bench.

### 2475 detector idle mode screen

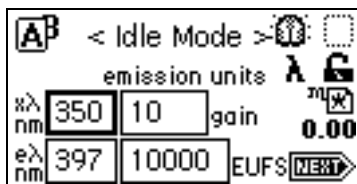

## Using the operator interface

### Using the display

The detector’s operator interface includes a 128 × 64 bitmap graphic display and a 24-key membrane keypad. The home screen appears as shown in below.

### Finding parameters in the fluorescence home screen

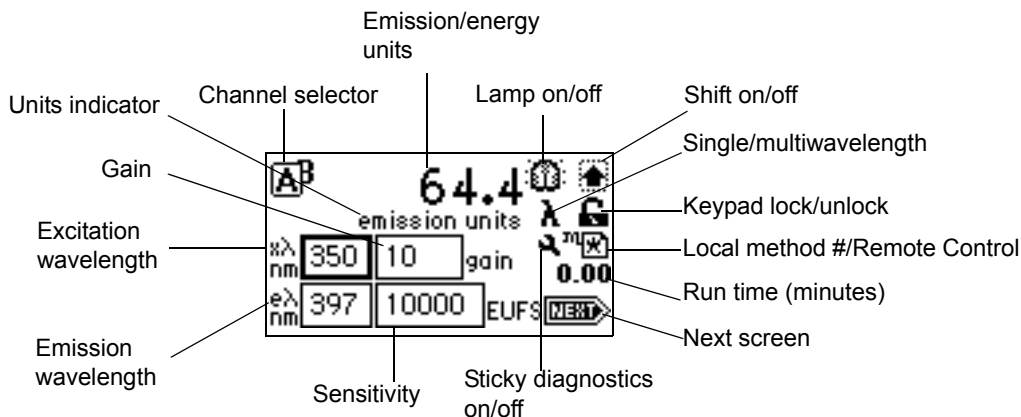

You can display the home screen anytime by pressing HOME. When you first use the detector, the home screen shows factory-set defaults. Afterward, it shows the settings displayed before the detector was last shut down. The home screen continues to change as the run continues.

In real time, the detector monitors fluorescence in terms of emission or energy units of one or more wavelength pairs. Simultaneously, you can modify all parameters in the [table titled “2475 detector home and message screen icons” on page 3-5](#). Press the A/B key to toggle between home screens for channels A and B.



## Fluorescence and message icons

The Fluorescence screens and message screens display the icons or fields shown on [page 3-4](#) and described in the following table. For a list of ranges and defaults for the function icons and fields in the following table, see the [table titled “Primary and secondary function \(method\) parameters” on page 3-21](#).





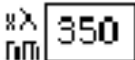

**Caution:** Changing the sensitivity (EUFS) setting affects the 1-V output. For example, setting sensitivity to 500 EUFS on a 1-V output gives 500 EU/V and a 250 EU signal gives 0.5-V.



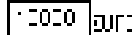





### 2475 detector home and message screen icons

Icon or field	Description	Function
	Excitation wavelength	Selects the digital fluorescence wavelength pair monitored on the selected channel. In single-channel mode, you cannot independently control a wavelength pair on channel B.
	Emission wavelength	Selects the digital fluorescence wavelength pair monitored on the selected channel. In single-channel mode, you cannot independently control a wavelength pair on channel B.









## 2475 detector home and message screen icons (Continued)

Icon or field	Description	Function
	Gain	Selects the PMT gain setting.
	Sensitivity (EUFS)	Selects the chart sensitivity in emission or sample energy units full scale (EUFS) for the selected channel (digital data is not affected).
	Channel selector	Changes the channel when you press A/B. The selected channel overlaps the other channel.
	Channel On	Displays the ON A or ON B icon for the channel on which a timed or threshold event is programmed.
	Channel trace	When you press TRACE, displays the fluorescence intensity, also known as emission, for the channel indicated (A or B).
Numerical field (0.00)	Fluorescence in emission units or sample energy units	Displays current normalized emission units or sample energy units for the selected channel that are not normalized.  The displayed units depend on the output units selected on the second screen of the operator interface.
emission units	Units indication	Displays the data units selection.
energy units		
	Lamp on	Indicates the lamp is on.

## 2475 detector home and message screen icons (Continued)





Icon or field	Description	Function
	Lamp off	Indicates the lamp is off.
	Shift off	Blank = Shift off
	Shift on	Indicates the shift is on for one key press.
	Single wavelength	Indicates the detector is operating in single-channel mode.
	Multiwavelength	Indicates the detector is operating in dual-channel mode.
	Triple wavelength	Indicates the detector is operating in triple-channel mode. Icon only appears if instrument is under control of an external data system (remote mode only).
	Quad wavelength	Indicates the detector is operating in quadruple-channel mode. Icon only appears if instrument is under control of an external data system (remote mode only).
	3D wavelength	Indicates the detector is operating in 3D-scan mode. Icon only appears if instrument is under control of an external data system (remote mode only).

## 2475 detector home and message screen icons (Continued)

Icon or field	Description	Function
	Keypad unlock	Indicates unrestricted keypad entry.
	Keypad lock	Indicates parameter changes are not allowed; instrument is under control of an external data system (remote mode only).
	Sticky diagnostic on	Indicates a sticky diagnostic setting is active. See <a href="#">page 5-8</a> , for an explanation of sticky diagnostic settings.
	Local method number	Indicates that the 2475 detector is not controlled by a data system. It displays either a cursive “m” and the current method number or an asterisk (*), which indicates current conditions are not stored as a method.
	RS-232 control	Indicates that the 2475 detector is controlled by a data system, and displays a remote control icon.
	Ethernet control	Indicates that the 2475 detector is controlled by a data system, and displays a remote control icon.
Numerical field (0.00)	Run time (minutes)	Displays the time elapsed since you pressed Run, or since an inject-start signal was received.
	Next	Indicates that pressing Next displays additional screens.
	Message screen icon.	Indicates an error message.



## 2475 detector home and message screen icons (Continued)

Icon or field	Description	Function
	Message screen icon.	Indicates a question.
	Message screen icon.	Indicates a warning message.
	Message screen icon.	Indicates information is being displayed.
	Message screen icon.	Indicates that you should standby.

## Using the keypad

The keypad (see the [figure “2475 detector keypad” on page 3-11](#)) consists of 24 keys, which provide these functions:

- Full numeric entry – 10 digits and a decimal point.
- Global functions – Enter, Shift, CE (Clear Entry), Next, and ? (Help).
- Navigation – ▲ and ▼ (used for navigation only; pressing ▲ can also move you to the previous column, ▼ to the subsequent column). On screens with a scrollable list, these keys move the highlight upward (toward the beginning of the list) or downward (toward the end).
- A/B – Toggles between channels A and B.
- Direct access to specific screens – HOME, METHOD, CONFIGURE, DIAG (Diagnostics), TRACE, and SCAN.
- Primary functions – Chart Mark, Auto Zero, and Run/Stop. Primary function keys take effect immediately, with no further entry required.
- Secondary functions – SCAN,  $\lambda/\lambda\lambda$  (single or multichannel), Reset (clock), Lamp, Lock, Calibrate, System Information, Contrast, Previous, Cancel, +/-, and Clear Field. Secondary function keys require you to

enter information into parameter fields, and then press Enter to actuate the specified functions.

Keys that appear in all-uppercase letters (HOME, METHOD, CONFIGURE, DIAG, TRACE, and SCAN) display a function, directly, from most screens.

Select a numerical entry on a list or menu as follows:

- For numerical entries 1 through 9 on lists or menus, enter the number corresponding to a desired item, and then press Enter.
- For the number 10, select 0, and then press Enter.
- To go to the end of a list, press •.
- For entries numbered 11 or 12, press the ▲ or ▼ key to scroll to a desired item on the list, and then press Enter.

**Tip:** The ▲ and ▼ keys do not incrementally increase or decrease field entries. To change field entries, use the numerical keypad.

## 2475 detector keypad

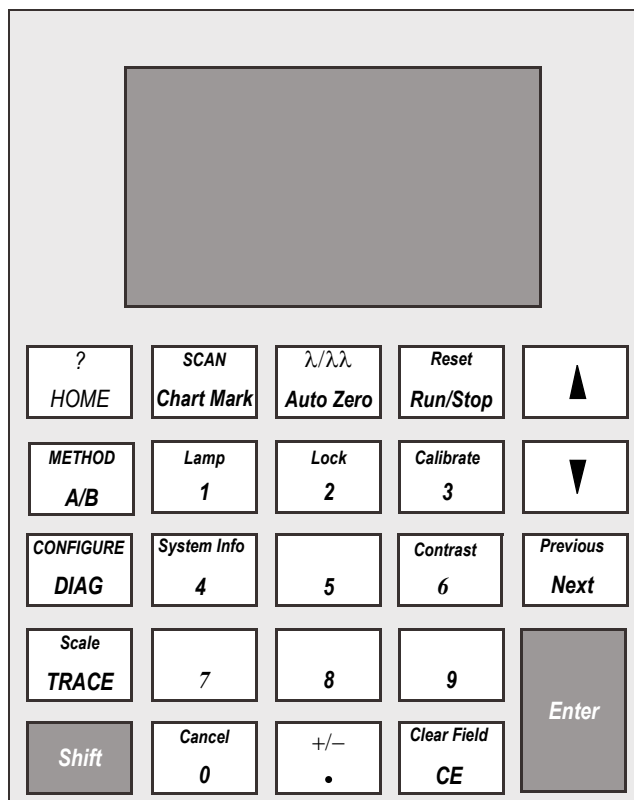



The following table explains the functions of the primary and secondary keys. To initiate a secondary function, press Shift and then the key.

### 2475 detector keypad description

Key	Description	
	Unshifted	After pressing shift
<div style="border: 1px solid black; padding: 5px; width: fit-content; margin: 0 auto;">                     ? HOME                 </div>	HOME – Displays the home screen, which displays icons, excitation and emission wavelengths, EUFS, and Gain fields.	? – Displays context-sensitive Help, when available.

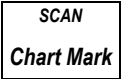
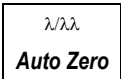
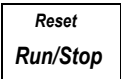
## 2475 detector keypad description (Continued)

Key	Description	
	Unshifted	After pressing shift
	<p>Chart Mark – Causes a momentary pulse to the analog output (A and B, depending on specified settings). This key has no effect if the chart mark function is disabled on both channels.<sup>1</sup></p>	<p>SCAN – Displays the list of options for generating and manipulating spectra.</p>
	<p>Auto Zero – Sets the fluorescence offset so that the analog output (A and B, depending on specified settings) reads 0 EU. This key has no effect if Auto Zero is disabled on both channels. You can enable or disable Auto Zero from the fourth home screen (see the <a href="#">figure “Secondary functions of the home screen” on page 3-17</a>).<sup>1</sup></p>	<p><math>\lambda/\lambda\lambda</math> – From the home screen, use this key to toggle between single and multichannel modes. The current mode is indicated by an icon on the display.</p>
	<p>Run/Stop – Starts or stops (freezes) the run clock and initiates scans. The elapsed time appears near the lower-right-hand side of the home screen. The shutter opens when you press Run while the idle mode function is enabled.</p>	<p>Reset – Resets the detector run clock to zero minutes and returns the detector to initial conditions for a current method. Closes the shutter and displays Idle Mode when the idle mode is enabled.</p>
 	<p>▲ and ▼ – On screens with entry fields (edit, check box, or list), the active field has a thick border. You can use the arrow keys to make a different field active. (▲ moves up or leftward; ▼ moves down or right.) On screens with a scrollable list, these keys move the highlight upward (toward the beginning of the list) or downward (toward the end). Other screens can have special instructions for using the ▲ and ▼ keys (for example, the display contrast screen).</p>	



## 2475 detector keypad description (Continued)

Key	Description	
	Unshifted	After pressing shift
<div style="border: 1px solid black; padding: 5px; width: fit-content; margin: 0 auto;"> <i>Previous</i>  <b>Next</b> </div>	<p>Next – Displays a screen with additional options related to the current screen. Repeatedly pressing this key always returns the display to the screen you started with. On most screens where this key is active, the NEXT arrow appears in the lower-right-hand corner.</p>	<p>Previous – When the Next key is available, Previous navigates through the screens in the reverse order.</p>
<div style="border: 1px solid black; padding: 5px; width: fit-content; margin: 0 auto;"> <b>METHOD</b>  <b>A/B</b> </div>	<p>A/B – On screens that have the A/B icon in the upper-left-hand corner, this key toggles between channel A and channel B parameters.</p>	<p>METHOD – Displays the list of options for creating and clearing timed and threshold events and storing, retrieving, and resetting methods.</p>
<div style="border: 1px solid black; padding: 5px; width: fit-content; margin: 0 auto;"> <b>CONFIGURE</b>  <b>DIAG</b> </div>	<p>DIAG – Displays the list of diagnostic routines.</p>	<p>CONFIGURE – Displays the first Configuration screen.</p>
<div style="border: 1px solid black; padding: 5px; width: fit-content; margin: 0 auto;"> <i>Scale</i>  <b>TRACE</b> </div>	<p>TRACE – Displays the fluorescence monitor trace for channel A or B.</p>	<p>Scale – When the wavelength trace or spectrum screen is visible, use this function to modify the display range in the X (time or wavelength) and Y (fluorescence) dimensions.</p>
<div style="border: 1px solid black; padding: 5px; width: fit-content; margin: 0 auto;"> <b>Shift</b> </div>	<p>Shift – Enables the shifted functions (identified by the text at the top of most keys). The shifted state is temporary (lasting for one keystroke only) and resets after the next keystroke.</p>	

## 2475 detector keypad description (Continued)

Key	Description	
	Unshifted	After pressing shift
<div style="border: 1px solid black; padding: 5px; width: fit-content; margin: 0 auto;">0-9</div>	0-9 – Enters the corresponding number into the current field. Also positions the cursor at the corresponding entry in a list (0 = tenth item). Selects the corresponding number from a list.	0-9 – See the descriptions that follow for specific, shifted, numeric keys.
<div style="border: 1px solid black; padding: 5px; width: fit-content; margin: 0 auto;">Lamp 1</div>	1 – See 0-9 above.	Lamp – Displays the lamp use statistics for the currently installed lamp and allows you to turn the lamp on or off. The state of the lamp is indicated by an icon on the home screen.
<div style="border: 1px solid black; padding: 5px; width: fit-content; margin: 0 auto;">Lock 2</div>	2 – See 0-9 above.	Lock – When you are viewing the home screen, enables or disables the keypad lock feature. Use the lock to prevent inadvertent changes to detector settings. The current lock state is indicated by an icon on the home screen.
<div style="border: 1px solid black; padding: 5px; width: fit-content; margin: 0 auto;">Calibrate 3</div>	3 – See 0-9 above.	Calibrate – Initiates the wavelength calibration routine.
<div style="border: 1px solid black; padding: 5px; width: fit-content; margin: 0 auto;">System Info 4</div>	4 – See 0-9 above.	System Info – Displays system information including software version, checksum, and instrument serial number.

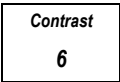
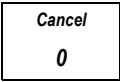
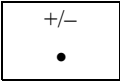
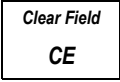
## 2475 detector keypad description (Continued)

Key	Description	
	Unshifted	After pressing shift
	6 – See 0-9 above.	Contrast – Use to adjust contrast (viewing angle) in the liquid crystal display.
	0 – See 0-9 above.	Cancel – In some modes, Cancel backs out of a prompt without completing the task. The word Cancel appears as a cue in the lower-right-hand border of the message.
	• – Enters a decimal point. Also positions the cursor at the last entry in a list.	+/- – Some edit fields accept negative number entry. Use this function to invert the sign of the number in the active field.
	CE – Clears an editing change, and returns the contents of a field to its previous value. Sets the value to a unique word for some fields. For example, in the voltage offset diagnostic, you can enter either a numeric offset value or press CE to change it to OFF.	Clear Field – Blanks the current entry field before you specify a new value.
	Enter – Completes the entry in an editable field. Also advances the active field, as if ▼ had been pressed (except after editing the wavelength on the home screen). Press Enter to acknowledge error messages and other prompts. In these cases, the word Enter appears as a cue in the lower-right-hand border of the message.	

1. Chart Mark and Auto Zero do not affect the output with reference energy selected.

## Navigating the user interface

Press Enter or ▲ and ▼ to navigate among editable fields. A thick border appears around the active field. When you complete an entry, press Enter to advance to the next active field.

If you make an error, press CE (Clear Entry) to undo any changes and return to the active entry field.

An active field containing a list has a number to the right of the field within the thick border. To display a list, press Enter, and then perform one of these actions:

- Press the corresponding number key to select an item immediately.
- Use ▲ and ▼ to scroll through the list, and then press Enter.

If you know the number corresponding to a choice, you can press that number without pressing Enter first.

The ▲ and ▼ keys do not incrementally increase or decrease numerical field entries. To change field entries, use the numerical keypad.

## Navigating to and from the home screen

Pressing HOME displays the home screen from most other screens. From the home screen, you can choose several secondary functions. To move to the home screen's secondary function screens, press Next. The secondary functions include these:

- Filter type
- Analog output specifications
- Time constant
- Data units selection
- Voltage offset
- Chart polarity
- Enable/disable several inputs
- Enable/disable external events

The values and settings you specify in the secondary function fields become part of a current method's conditions and are retained when you store the method (see [page 3-43](#)).



When you press Next, the detector displays three additional home screens, labeled “2 of 4”, “3 of 4”, and “4 of 4” (see the [figure “Secondary functions of the home screen” on page 3-17](#)).

### Secondary functions of the home screen

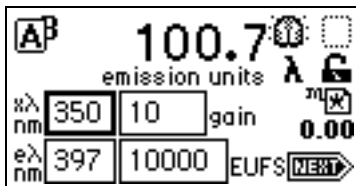

Fluorescence home screen

Press Next



filter type, analog out, and time constant (available for both λ and λλ)

Press Next

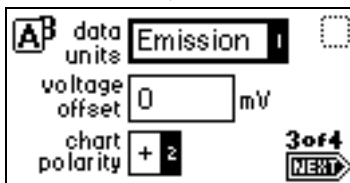

data units selection, voltage offset, and chart polarity (available for both λ and λλ)

Press Next

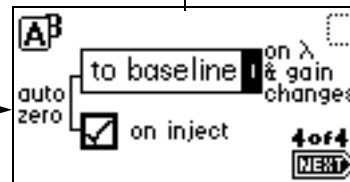

auto zero-on-inject, gain, and λ changes.

Press Next

## Preparing to start a run

---

You must set up a run before you make fluorescence measurements. To start a run, you can press Run/Stop or trigger the detector's operation via the inject-start terminals on the rear panel. When you start a run, the shutter opens automatically and the detector performs an auto-zero function (when the function is enabled).

You must select Auto Zero-On-Inject for the detector to automatically auto zero (see [page 3-19](#)).

While under Empower or Millennium<sup>32</sup> control (see [page 3-29](#)), the shutter closes when the detector finishes a run, and the run timer stops and then resets. If you run the detector manually, you can close the shutter by pressing Reset or waiting until the run ends.

To avoid the automatic opening and closing of the shutter, you can disable the idle mode by checking the Selection box in the Configuration screen (see [page 3-4](#)).

## Setting up a run

After you press HOME to return to the home screen and select a channel mode ( $\lambda$  or  $\lambda\lambda$ ), you can set up the detector for a run. Before beginning a run, however, you must select the channel mode, and program the following parameters:

- Operating wavelength pairs  
**Tip:** The emission  $\lambda$  setting ( $e\lambda$ ) must be at least 10 nm above the excitation  $\lambda$  setting ( $x\lambda$ ).
- Gain
- Output sensitivity, EUFS
- Filter type
- Time constant
- Analog output type
- Data units

If you want to perform other functions during a run, you must program other parameters. “[Accessing primary and secondary functions](#)” on [page 3-19](#) and the [table titled “Primary and secondary function \(method\) parameters”](#) on

page 3-21 describe the functions, fields, screen number, display units, allowable ranges, and default settings for the home screen and its secondary function screens.

## Accessing primary and secondary functions

You can access the primary and secondary functions from the home screen or by pressing Next.

- Excitation Wavelength – Defines the operating excitation ( $x\lambda$ ) wavelength for the channel.
- Emission Wavelength – Defines the operating emission ( $e\lambda$ ) wavelength for the channel.
- EUFS (emission/sample energy units full scale) – Defines the relationship between the fluorescence signal response (EU) and the analog output voltage. The output voltage reaches full scale when fluorescence attains the EUFS value.



**Caution:** Changing the sensitivity (EUFS) setting affects only the 1-V output. The digital output at the RS-232 connector remains unchanged.

- Gain – This setting controls the full-scale sensitivity of the detector by defining the PMT gain factor from 1 to 1000. Each gain setting must have a linear relationship with the actual fluorescence signal.
- Filter type – Defines your choice of noise filter (Hamming filter is the default).
- Data units – Defines data units.
- Emission – The standard chromatography mode of the detector, which normalizes the output to a water standard in emission units. Emission units are measurements of light that are independent of PMT gain. Through normal use, the optics in any detector age and, therefore, change, resulting in measurement variation over time. By using emission units, you can eliminate optics deterioration as a variable in your measurements. When emission units are used, measurements taken on different 2475 detectors are fully compatible with one another.
- Energy – Energy units do not have the normalization advantage. Those traditional units of measurement conform to currently established test methods. However, the results depend greatly on PMT gain.

- Analog out (single  $\lambda$  pair)
  - Emission – Fluorescence output corresponding to the data units selected.
  - Reference Energy – Charts the lamp energy from the reference photodiode located in the excitation optic bench. Reference scaling is fixed at 10,000 units per volt.
  - Output Off– Output set to zero volts.
- Analog out (multi  $\lambda\lambda$ ) – In addition to the selections for single  $\lambda$ , you can chart the same parameters on the other channel at a different excitation and emission wavelength pair, and you can chart the following parameters:
  - MaxPlot – Charts the fluorescence of multiple compounds with different fluorescence values at different excitation and emission wavelength pairs on a single data channel. Scaling for MaxPlot is the same as for Fluorescence, except that the charted fluorescence is the larger of the fluorescences measured on channels A, B, C, and D. The detector uses the EUFS, data offset, and voltage offset of the selected fluorescence channel regardless of which channel is larger.  
Volts out = Larger fluorescence (A or B)  $\times$  1 V/EUFS (of selected channel)
  - Difference Plot (A-B and B-A) – Charts the difference in fluorescences at two different wavelength pairs. The scaling for the difference plot is identical to emission or sample energy selections, except that the charted fluorescence is the difference in value of the two fluorescences measured on channels A and B. The detector uses the EUFS (of the selected channel), emission offset, and voltage offset of the selected channel for scaling.  
Volts out = Fluorescence difference (A – B or B – A)  $\times$  1 V / EUFS
- Time constant – Adjusts the noise filter (time constant) to achieve the optimum signal-to-noise ratio without changing the sensitivity setting (see [page 1-12](#)).
- Voltage offset – Adjusts the charted analog output signal. Specified in millivolts, voltage offset adjusts the 1-V signal by the entered value. This is useful for making minor adjustments, and for nulling any offset between the detector and a connected external data system.
- Chart polarity – Inverts the chromatogram on the analog output. Entering the plus symbol (+) produces a normal chromatogram; entering

the minus symbol (–) produces an inverted chromatogram at the analog output channel.

- Auto Zero-On-Inject – Selected by default, this parameter specifies the auto-zero behavior each time the detector receives an inject-start signal. You can disable this parameter by pressing any numerical key to clear this field for either or both channels.
- Auto Zero on  $\lambda$  and gain changes – This function produces an auto zero each time a wavelength change or gain change is requested. If you disable it, significant changes in measured fluorescence can occur after each wavelength change. Selecting “to zero” sets the signal level to zero. Selecting “to baseline” maintains the previous baseline level when the gain or wavelength change is made. “To baseline” is the default setting.
- Enable keypad & event-in chart mark – Selected by default, this parameter results in a chart mark each time one is requested. You can disable this parameter by pressing any numerical key, clearing this field for either or both channels. Chart marks work with analog channels only.

### Primary and secondary function (method) parameters

Function	Screen	Type	Units	Range	Default
x $\lambda$ (Excitation wavelength)	home	Numeric	nm	Integer 200 to 890 nm	350 nm
e $\lambda$ (Emission wavelength)	home	Numeric	nm	Integer 210 to 900 nm	397 nm
<b>Tip:</b> The emission $\lambda$ setting must always be at least 10 nm above the excitation $\lambda$ setting.					
Gain	1	Numeric	Emission or energy units	0 to 1,000	0
EUFS	1	Numeric	EUFS	1 to 100,000	10,000
Filter type	2 (of 4)	Choice	None	<ul style="list-style-type: none"> <li>• Hamming</li> <li>• RC</li> <li>• None</li> </ul>	Hamming

### Primary and secondary function (method) parameters (Continued)

Function	Screen	Type	Units	Range	Default
Analog out (single $\lambda$ )	2 (of 4)	Choice	None	<ul style="list-style-type: none"> <li>Emission A</li> <li>Reference energy A</li> <li>Output off</li> </ul>	Emission A
Analog out (multi $\lambda\lambda$ )	2 (of 4)	Choice	None	<ul style="list-style-type: none"> <li>Emission A</li> <li>MaxPlot A, B, C, D</li> <li>Diff (A-B)</li> <li>Diff (B-A)</li> <li>Reference energy A</li> <li>Output off</li> </ul>	Emission A
Time constant	2 (of 4)	Numeric	sec	<ul style="list-style-type: none"> <li>Hamming (<math>\lambda</math>): 0.1 to 5.0</li> <li>Hamming (<math>\lambda\lambda</math>): 1 to 50</li> <li>RC(<math>\lambda</math>): 0.1 to 99</li> <li>RC(<math>\lambda\lambda</math>): 1 to 99</li> <li>0 to disable filtering</li> </ul>	1.5
Data units	3 (of 4)	Choice	None	<ul style="list-style-type: none"> <li>Emission</li> <li>Energy</li> </ul>	Emission
Voltage offset	3 (of 4)	Numeric	mV	Integer -1000 to +1000	0
Chart polarity	3 (of 4)	Choice	None	+ -	+

## Primary and secondary function (method) parameters (Continued)

Function	Screen	Type	Units	Range	Default
Auto Zero on inject	4 (of 4)	Check box	None	Checked not checked	Checked
Auto Zero on $\lambda$ changes	4 (of 4)	Choice	None	<ul style="list-style-type: none"><li>To baseline</li><li>To zero</li><li>Disable</li></ul>	To baseline

## Operating the trace and scale functions

The trace function displays a fluorescence signal for the last  $n$  minutes (up to and including 60) of detector operation.

- Press TRACE to display fluorescence acquired over the last 30 minutes by default. The trace is updated once every 20 seconds.
- Select Scale (Shift, TRACE) to display the scaled trace, which shows T1, the ending time (-30 for the last 30 minutes), by default.

You can change the ending time, specifying any number from 3 through 60. You can use the scale function to zoom in on a particular section of the trace.

## Displaying the scale parameters

### To display the scale parameters:

1. Press Scale.
2. Press Next to display T2 (starting time). The default is 0.
3. Press Next again to display EU1 (starting or low fluorescence). The default is auto.
4. Press Next again to display EU2 (ending or high fluorescence). The default is auto.

By entering appropriate times and fluorescence numbers in the four scaling parameter boxes, you can zoom in on one section of an ongoing fluorescence trace.

- For EU1 and EU2, press CE to reset to auto.

- T1 represents the left-hand side of the trace, or ending time (default is -30).
- T2 represents the right-hand side of the trace, or starting time (default is 0).

The following figure shows a 60-minute trace of continuous injections of salicylic acid and naproxen with the excitation wavelength set to 240 nm and emission to 355 nm.

### Scaled trace of continuous injections with T1 changed to -60

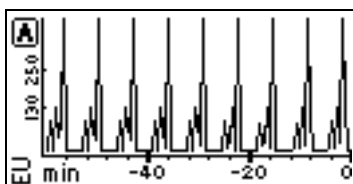

The following figure shows a 4-minute scaled trace (or zoom) of the 60 minutes of continuous injections shown in the previous figure. T1 is changed to -4. T2 is changed to 0. EU1 and EU2 remain as auto.

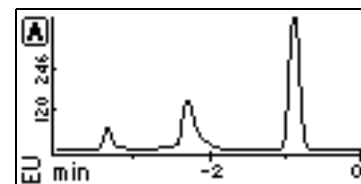

### Scaled trace for 4 minutes changing T1 to -4

The following figure shows a 60-minute trace on channel A scaled to the last 15 minutes. T1 is changed to -15.

### Scaled trace changing T1 to -15

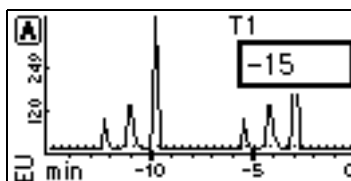
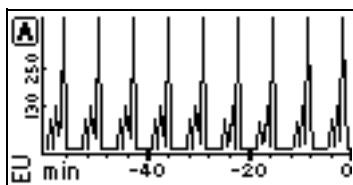



As you modify the output using the scale function, the trace function continues to display the 2475 detector output in real time on either or both channels.

## Configuring the detector

You can configure the detector to emulate the Waters 474 detector communication protocol in the Configuration screens. Select CONFIGURE (Shift, DIAG). The first of three Configuration screens appears. Then select 474 emulation.

**Tip:** Other functions, such as specifying event inputs and enabling pulse periods, are also available in the Configuration screens.

### Configuration screens

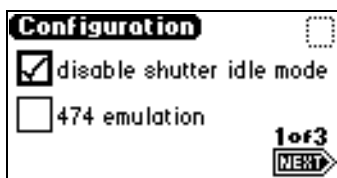

Configuration screen 1 of 3

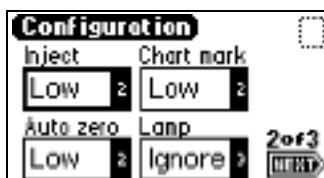

Configuration screen 2 of 3

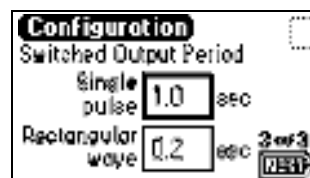

Configuration screen 3 of 3

### Disabling shutter idle mode

You can disable the shutter idle mode in the first Configuration screen. When selected, the shutter does not close to protect the detector's optics after the completion of a run to protect the detector's optics (see [page 3-4](#)).

## Configuring event inputs and contact closures

You can also use CONFIGURE to edit event input settings and specify switched output settings. Use Enter and the numeric keypad or ▲ and ▼ to select the appropriate entry.

The second Configuration screen includes four editable entry fields.

- Inject – You can specify an inject-start input to signal the start of a run, an event that resets the run-time clock and applies initial method conditions immediately:

- High – Starts run when contact closure changes from off (open) to on (closed).
  - Low – (Default) starts run when contact closure changes from on (closed) to off (open).
  - Ignore – No response to inject-start input.
- Chart mark – You can specify a chart mark input to create a chart mark on channel A and/or channel B. To determine the response of the channel, enable the chart mark function (see the [table titled “Primary and secondary function \(method\) parameters” on page 3-21](#) and the [figure “Secondary functions of the home screen” on page 3-17](#)):
  - High – Creates a chart mark(s) when contact closure changes from off (open) to on (closed).
  - Low – (Default) creates a chart mark(s) when contact closure changes from on (closed) to off (open).
  - Ignore – No response to chart-mark input.
- Auto Zero – You can configure the auto-zero input to auto zero fluorescence readings on channel A and/or channel B. To determine the response of the channel, enable the auto-zero function (see the [table titled “Primary and secondary function \(method\) parameters” on page 3-21](#) and the [figure “Secondary functions of the home screen” on page 3-17](#)):
  - High – auto zeroes the channel when contact closure changes from off (open) to on (closed).
  - Low – (Default) auto zeroes the channel when contact closure changes from on (closed) to off (open).
  - Ignore – No response to auto-zero input.
- Lamp – You can configure the Lamp input level to turn the xenon lamp on or off from an external device:
  - High – Turns lamp on when contact closure is on (closed).
  - Low – Turns lamp on when contact closure is off (open).
  - Ignore – (Default) does not respond to Lamp input.

## Setting pulse periods

In the third Configuration screen (see the [figure “Configuration screens” on page 3-25](#)), you set the pulse width or activate a rectangular wave on SW1 or

SW2. The figure “Setting the pulse period or signal width on SW1 or SW2” on page 3-27 shows a single pulse and a rectangular wave.

- Single pulse (in seconds) – If SW1 or SW2 is programmed to generate a pulse as a timed or threshold event, then this field specifies the period of the signal (single pulse width; range 0.1 to 60 seconds).
- Rectangular wave (in seconds) – If SW1 or SW2 is programmed to generate a rectangular wave as a timed or threshold event, then this field specifies the period of the signal (the width of one pulse period in a rectangular wave or pulse train; range 0.2 to 60 seconds).

### Setting the pulse period or signal width on SW1 or SW2

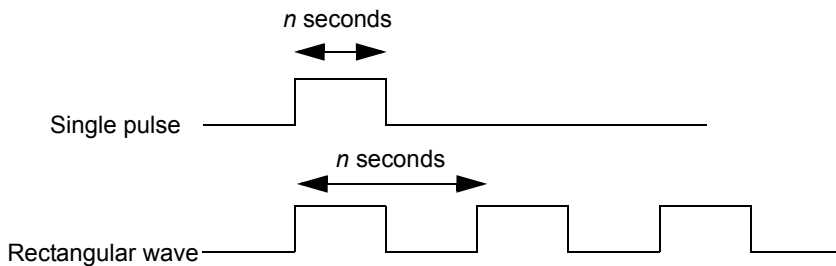

## Setting the Display Contrast

Using the contrast function, you adjust the contrast of the detector display screen. When you select Contrast (Shift, 6), the Display Contrast screen appears. Use ▲ and ▼ to adjust the contrast of the display, and then press Enter.

### Display Contrast screen

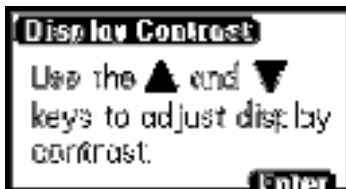

## Displaying system information

Select System Info (Shift, 4) for information about the detector, including (where applicable) the serial number, software version number with checksum, and version date. Press Enter to return to the home screen.

### Example of a System Info screen

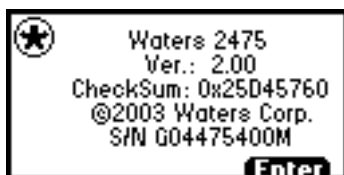

**Tip:** The 2475 detector release notes also reflect the checksum and version.

## Using Online Help

The detector has limited context-sensitive Help. When you select “?” (Shift, HOME) from a point in the program associated with a Help screen, the screen appears. If Online Help is not available, selecting “?” effects no response. Press Enter to return to the home screen.

### Example of a Help screen

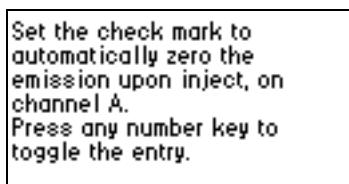

## Operating the detector

---

- If you are operating the detector under the control of an external data system, you can program any parameters not controlled by the external data system at the detector's front panel before the external system takes control.
- To prevent resorption of dissolved oxygen, sparge or run the solvent degasser continuously when operating the detector (see [Appendix C](#)).

## Two operating modes

You can use the detector in either single-channel or multichannel mode over a range of 200 to 900 nm. The detector defaults to its mode of operation when last shut down.

When the detector is operating in single-channel mode, you can configure analog outputs on channel B. In single-channel mode, the detector tracks a single wavelength on both channels A and B. You can use channel B for these purposes:

- Track fluorescence (EU) at an alternate EUFS.
- Monitor sample or reference energy outputs.
- Set a different time-constant.

The [table titled “Primary and secondary function \(method\) parameters” on page 3-21](#) includes more information on operating parameters adapted in single or multichannel mode. When an Empower or Millennium<sup>32</sup> data system controls the detector, it functions as a Waters 474 detector (see [page 3-29](#)).

## Standalone operation

When using the detector as a standalone instrument, you can store up to 10 methods, each containing up to 48 timed and 2 threshold events (see [page 3-43](#)). An asterisk in the method number field on the home screen indicates conditions at the time of a run, not a stored method.

## Remote control operation for 474 emulation mode via RS-232

The remote control icon appears on the home screen (see the [figure “Finding parameters in the fluorescence home screen” on page 3-4](#) and the [table titled “2475 detector home and message screen icons” on page 3-5](#)) when an external data system controls the detector. Under Empower or Millennium<sup>32</sup> control for 474 emulation, the detector uses the RS-232 connector (see [page 2-18](#)), and an “R” appears within the remote icon, which itself appears on the busLAC/E data system’s configuration screen as a 474 detector when the Emulate 474 option is enabled and operating in single-channel mode.

To connect the detector to an HPLC system, see [page 2-3](#). To connect the detector to an external system, see [page 2-5](#).

## Instrument setup

### To set up the instrument:

1. On the configuration screen (Shift, DIAG), configure the detector to operate in 474 Emulation mode.
2. Connect the detector via a standard RS-232 cable to any available COM port on a Millennium<sup>32</sup> PC.
3. In the operating system's device manager, check to ensure the COM port you connected the detector to is available.

**Tip:** The same parameters apply to a 474 detector.

### PC configuration for remote control

Parameter	Value
Baud rate	4,800
Stop bits	2
Parity	None
Data length	8 bits
Flow control	Xon/Xoff

### Method parameters

The initial conditions for the method are specified on the General tab of the fluorescence method editor in Empower or Millennium<sup>32</sup> software.

**Tip:** The 2475 detector and the 474 detector interpret some method parameters differently.

### Example of method parameters

Parameter	Value
Excitation $\lambda$ (nm)	350
Emission $\lambda$ (nm)	397
Bandwidth (nm)	18
Filter Type	Digital
Filter Response	10

### Example of method parameters (Continued)

Parameter	Value
Lamp Off Time (hrs)	1.0
Sampling Rate	2
Offset (mv)	0
Gain	1
Attenuation	64
Auto Zero	Auto
Polarity	+

- Excitation ( $x\lambda$  or Ex) and Emission ( $e\lambda$  or Em)  $\lambda$  (nm) – Wavelength setpoints for the two monochromators. The detector's excitation range is 200 to 890 nm and emission range is 210 to 900 nm. You must set the emission wavelength at least 10 nm above the excitation wavelength.  
**Tip:** If any of these conditions are ignored, a detector error occurs, and the sample set can be suspended.
- Bandwidth (nm) – Not an adjustable parameter on the detector, so the value in this field is ignored. However, the static bandwidth of a detector is 20 nm, so an entry of 18 nm in this field would document a value close to the actual value in the method (for sample detail archival purposes in Empower or Millennium32 software).
- Filter Type – Either a digital (Hamming) or RC filter. The digital filter tends to yield peaks with far less distortion than does a standard RC filter. The RC filter serves the need of those who want to follow established measurement conventions.
- Filter Response – Time-constant setting of the filter (3, 5, 10, 20, and 40). The 474 detector interprets these numbers in terms of seconds. However, values of this magnitude are too high for chromatography, so the 2475 detector interprets these inputs at one tenth the specified value.

When you select RC as the filter type, only three response choices are possible (Fast, Std., and Slow). These are the time-constants associated with those selections:

- Fast = 0.5 sec.
- Std. = 1.5 sec.
- Slow = 4.0 sec.

### Digital time constant response settings

Empower or Millennium <sup>32</sup> selection	2475 time constant (sec.)
3	0.3
5	0.5
10	1.0
20	2.0
40	4.0

- Lamp Off Time (hrs) – Determines how long after the start of an injection the lamp turns off. The timer resets at the beginning of every injection. Typically, you can set this function to a value that is comfortably longer than the runtime of any injection. For example, if your longest runtime is 30 minutes, choose a Lamp Off Time selection of 2 hours. By leaving 90 minutes of idle “lamp on” time, you can easily start another sample set without having to wait for the lamp to warm again.

**Tip:** It is best to shut the lamp off only when all runs are completed. You should program the lamp to turn off (or turn off the lamp manually) only when you do not expect to use it for at least four hours.

- Sampling Rate – Number of data points per second that the detector transmits to Empower or Millennium<sup>32</sup> software.
- Offset – Level of offset, in millivolts, applied to the channel A analog output only. It does not affect the digital data transmitted to Empower or Millennium<sup>32</sup> software over RS-232.
- Gain – Gain value applied to the PMT. The choices are 1, 10, 100, and 1000.
- Attenuation – Analogous to EUFS. Values from the 474 detector are translated according to the following table. This parameter affects only



the data on the channel A analog output, not the data output to Empower or Millennium<sup>32</sup> software through the RS-232 connection.

#### 474 and 2475 attenuation values

474 attenuation constants	2475 translation to EUFS
S (short)	1
1	1
2	10
4	50
8	100
16	500
32	1,000
64	5,000
128	10,000
256	100,000

- Auto Zero – Corresponds directly with enabling (Auto) and disabling (Manual) the automatic Auto Zero on injections, gain, or wavelength changes. You change these settings via the boxes on page 4 of the 2475 operator interface. If you select manual, the detector performs an Auto Zero only when directly commanded to do so, either as a timed event, front panel button, or rear panel (terminal block) contact closure. If you select auto, it performs an Auto Zero at the start of any injection or when the wavelength or gain is changed.
- Polarity – Defines the polarity of the analog output only.

#### Operation details

- Inject Start – The detector is configured with a switch-closure signal input to the chart mark terminal on the rear panel. A signal input starts injection run timer. You can also attach the wire to the inject start terminal on the rear panel.
- Compatibility with the Waters 474 detector – Separation methods for the 2475 and 474 detectors are compatible except for their gain values. See [page 3-19](#), “Emission (A & B)” and “Sample Energy (A & B).” The higher sensitivity of the 2475 detector’s flow cell produces significantly higher signals. Thus gain values optimized for the 474 detector can yield

saturated, highly distorted measurements when you apply them to the 2475 detector. You must therefore reduce the 2475 detector's gain setting as much as tenfold when using a method developed for the 474 detector. A gain setting of 1 suffices in most cases because of the 2475 detector's favorable signal-to-noise ratio.

- Sample Energy or Emission Units – Empower or Millennium<sup>32</sup> software can accept either sample energy or emission units. You can edit the data field Channel Description when creating an Empower or Millennium instrument method to record the units used, selecting the units from the Analog Out field on the second of the four home screens.
- Run Time – The run time is not synchronized with that of Empower or Millennium<sup>32</sup> software. However, the run time (and therefore programmed timed events) is synchronized with the recorded time axis of the chromatogram in Empower and Millennium<sup>32</sup> software.

## Remote control operation via Ethernet connection using 2475 instrument control software

This mode of operation uses the Ethernet connection and appears in the Empower software Configuration window as a 2475 detector. The remote control also icon appears on the detector's home screen (see the [figure “Fluorescence home screen” on page 3-3](#)) with an “E” at its center (see the [table titled “2475 detector home and message screen icons” on page 3-5](#)). For this mode of operation, you must disable the Emulate 474 option from the Empower Configuration window.

## Verifying the detector

Perform tests to verify wavelength accuracy (see [page 3-35](#)) and optimize emission units (see [page 3-36](#)). Doing so ensures no components in the flow cell interfere with the erbium lines at 379 and 522 nm. Completing these procedures successfully ensures that the detector's optics and electronics function properly.

**Tip:** Before you pump solvent or mobile phase through the system, flush the lines with filtered, degassed, and sparged HPLC-grade water. Then pump the mobile phase, provided you encounter no miscibility problems, at 1 mL/min for 15 minutes, minimum.

## Manual wavelength calibration

You can calibrate the detector manually from the keypad by pressing the manual calibration key at any time during detector operation or when calibration errors arise during startup. You need not restart the detector after a successful wavelength calibration.

**Tip:** Before you pump solvent or mobile phase through the system, flush the lines with filtered, degassed, and sparged HPLC-grade water and continue to pump at 1 mL/min.

### To manually calibrate the wavelength:

1. Select Calibrate (Shift, 3) from the keypad.

#### Wavelength calibration message

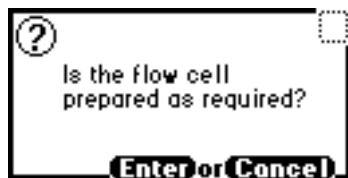

2. Ensure the flow cell is prepared, and then press Enter.

The detector cycles through the calibration procedure and momentarily displays a series of initialization messages similar to those displayed at startup. If calibration is successful, the detector beeps three times.

If the maximum error is greater than 2.0 nm, the detector displays the maximum error of the farthest calibration shift from the previous calibration.

#### Calibration successful message

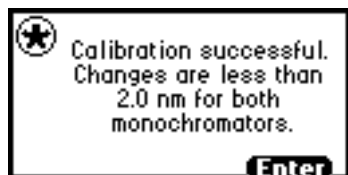

3. Press Enter. A "Calibration complete" message appears momentarily. Other messages, such as "Optimizing system performance" and "Restoring last setup", can appear before the home screen reappears.

4. If calibration is not successful, repeat it.
5. If calibration is still not successful, shut down the detector and restart it (see [Chapter 5](#)).
6. Run the detector normalization diagnostic test (see [page 3-36](#)).

**Requirement:** If this test yields a failing result, repeat it.

## Normalizing emission units

You can select either emission or energy units in the Output field of page 2 (see [page 3-19](#)). If you select emission units, normalize to a standard water reference on a monthly basis to ensure that measured signal strengths are as consistent as possible with those measured by other 2475 detectors.

**Tip:** Before you pump solvent or mobile phase through the system, flush the lines with filtered, degassed, and sparged HPLC-grade water. Then pump the mobile phase, provided you encounter no miscibility problems, at 1 mL/min for 15 minutes, minimum.

**Tip:** Normalize emission units weekly.

### To normalize emission units:

1. Power-on the detector, and allow it to warm and stabilize for at least 1 hour.
2. Run clean, degassed water through the flow cell at 1 mL/min (or a flow rate sufficient to prevent the formation of air bubbles).
3. Press DIAG, and then press 1 Normalize Units.

The detector adjusts the PMT gain, and it sets the excitation monochromator wavelength to 350 nm. The emission monochromator scans from 390 to 405 nm to find the Raman signal for water (397 nm), minimizing the occurrence of wavelength accuracy errors from distorting the normalization constants. After the emission monochromator finds this signal peak, PMT gain is optimized, and the normalization constants appear.

## Normalization values at completion

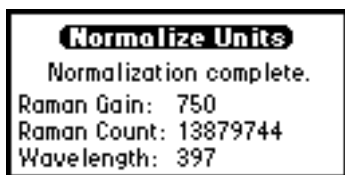

The values are used in the emission units formula described on [page 1-14](#). As the lamp and optics age, the Raman Gain will gradually increase to a maximum of 1000, and the Raman Counts value can decrease. If the Raman signal for water occurs within 3 nm of 397 nm, the normalized units are embedded in the detector's memory. If the signal fails to occur within that range, the detector does not save the values but instead preserves the prior constants.

**Tip:** If the Raman signal is not within 3 nm of 397 nm, usually something other than pure water is in the flow cell or the flow cell is dirty.

## Operating the detector in single-channel mode

The detector is optimized for single-channel ( $\lambda$ ) operation, the default operating mode.

### To specify single-channel mode when the detector is in multichannel mode:

1. From the home screen, select  $1/\lambda\lambda$  (Shift, Auto Zero).

**Result:** The detector displays an appropriate message while switching to single-channel operation.

2. Enter the wavelength, gain, and sensitivity on the home screen. Also enter any secondary parameters, timed events, or threshold events (see the [figure "Secondary functions of the home screen" on page 3-17](#) and the [table titled "Primary and secondary function \(method\) parameters" on page 3-21](#) through the [table titled "Threshold events "To" parameters" on page 3-48](#)).

**Tip:** Changing the sensitivity (EUFS) setting affects the 1-V output.

3. To select a second sensitivity setting while in single-channel mode, press A/B, and enter the appropriate EUFS on the channel B screen.

**Tip:** A single channel is tracked on channel A, leaving channel B available for monitoring emission with an alternate EUFS setting. You

can also use the Energy setting on channel B while making the primary fluorescence measurement specified by a EUFS on channel A. For example, while operating in single-channel mode, you can set an EUFS of 500 on the second channel, providing a different scaling factor on the channel B 1-V output.

The detector engages the second-order filter for all excitation wavelengths greater than 400 nm.

You can configure the detector to show the measurement results in either emission units or energy units (see [page 3-19](#)).

## Operating the detector in multichannel mode

You can operate the detector with expanded chart-out selections in multichannel ( $\lambda\lambda$ ) mode, which offers the following functions:

- Emission (A and B)
- Sample energy (A and B)
- Reference energy (A and B)
- MaxPlot
- Difference (A-B) or (B-A)

For details about these functions, see [page 3-19](#) and the [table titled “Primary and secondary function \(method\) parameters” on page 3-21](#).

## Changing from single to multichannel mode

### To change from single to multichannel mode:

1. From the home screen in single-channel mode ( $\lambda$ ), select  $\lambda/\lambda\lambda$  (Shift, Auto Zero).  
This key toggles between single and multichannel mode, and the detector displays a message indicating it is setting up multichannel operation.
2. Specify the excitation wavelength to monitor in the  $x\lambda$  field, and then press Enter.
3. Specify the emission wavelength to monitor in the  $e\lambda$  field, and then press Enter.

4. Specify the other operating parameters and any timed or threshold events, if desired.
5. Specify the desired gain.
6. Press A/B to switch channels. The home screen for the other channel appears.
7. Specify the operating parameters for the second excitation and emission wavelength pair monitor, the gain, and any timed and threshold events, if desired.

For more information on operating the detector in single-channel mode, see [page 3-37](#).

For more information on programming timed and threshold events, see [page 3-43](#).

**Tip:** In multichannel mode, do not set the gain setting for each channel individually.

## Obtaining a MaxPlot or difference plot

You can obtain a MaxPlot or difference plot by monitoring fluorescence at two selected wavelengths while plotting the maximum fluorescence for each sample component. Be sure the detector is operating in multichannel mode.

### To obtain a MaxPlot or difference plot:

1. From the home screen, press Next.  
Screen 2 of 4 appears (see the [figure “Secondary functions of the home screen” on page 3-17](#)).
2. Select the filter type (Hamming is the default) in the first field, and press Enter.
3. In the second field (analog out), make the appropriate selection:
  - 3, maxplot A,B
  - 4, difference A-B
  - 5, difference B-A
4. Press Enter to select the MaxPlot function.
5. Return to the home screen by pressing HOME.

## Setting gain and EUFS

Choosing a gain setting for the PMT before injecting sample is a necessary part of fluorescence measurement with detectors that use PMTs. For the best signal-to-noise ratio, set a gain that maximizes the dynamic range of the electronics (see [page 1-17](#)). A gain that is too high overloads the pre-amplifier, and a value of -9999.9 appears in the Emission/Energy units field.

### Gain set too high (fluorescence pinned to -9999.9 EU)

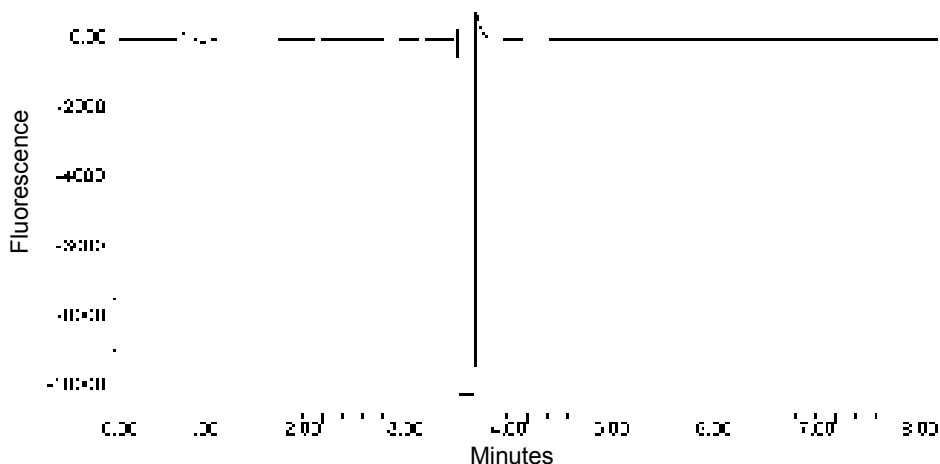

### Gain set too high alarm message



The value of -9999.9 EU in the Emission/Energy Units field and the alarm help differentiate between too high a gain setting and too low an EUFS setting. When the EUFS is set too low, flat-topped peaks appear, because the upper limit of the output range is exceeded.

**Tip:** An EUFS over-range situation occurs only when you use the analog outputs.



## EUFS set too low (flat-topped peak)

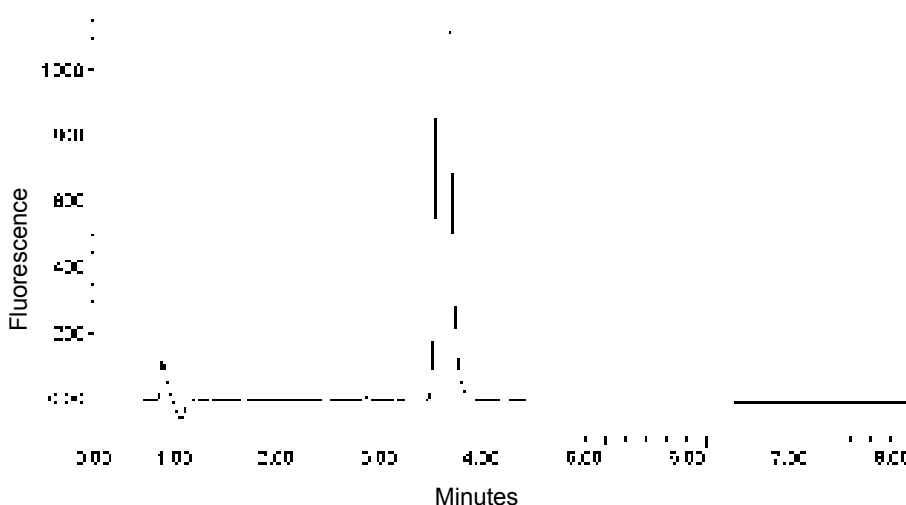

## Auto-optimizing gain and EUFS

The auto-optimize gain diagnostic test allows the detector to run a single trial chromatogram and suggests the ideal gain values to optimize the dynamic range of the signal collection electronics. You must program a separation method for the trial chromatogram. This can be done by entering a method via the keypad or by retrieving a previously created method from a stored memory location.

If you are using Empower or Millennium<sup>32</sup> software, you must enter the method into the 474 Fluorescence Detector Instrument method editor. The method is then downloaded to the 2475 detector when you make an injection.

After you program the method into the 2475 detector (or Empower or Millennium<sup>32</sup> editor), press DIAG, and then press 3 Auto-Optimize Gain.

## Selecting the auto-optimize gain diagnostic test

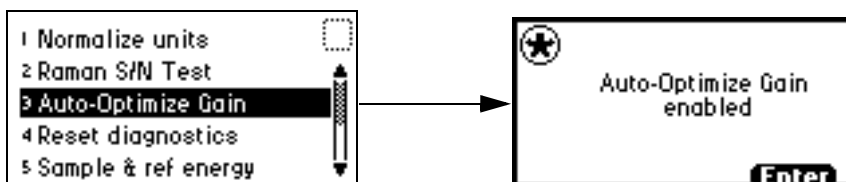

Selecting Auto-Optimize Gain prepares the diagnostic to be executed on the next injection. The sticky diagnostic (wrench) icon appears on the home screen, and <Auto Gain> appears in the emission field.

### Auto-optimize gain diagnostic test is implemented

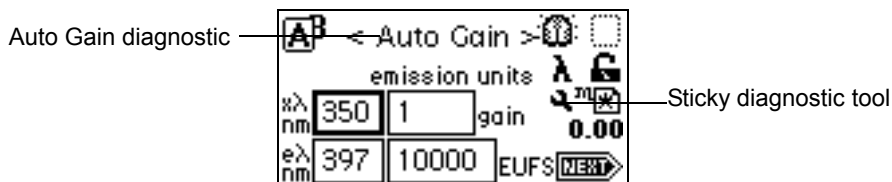

You can start the injection after you arm the diagnostic with a start pulse trigger from an injector input to the inject event terminal on the detector rear panel. You can also press Run/Stop on the front panel as the sample is injected into the fluid stream.

**Tip:** You must synchronize the start trigger with the chromatography so that the timed events occur at proper times relative to the peaks.

Select Make Injection if you are running under Empower or Millennium<sup>32</sup> control, or start the injection through other devices (such as an Alliance 2695 Separations Module).

**Tip:** The gain setting appears as 1 during the auto-optimize gain run.

### Gain set to 1 automatically during the auto-optimize gain run

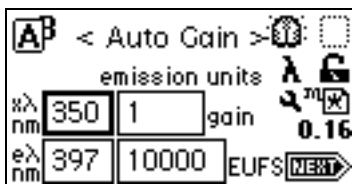

The detector runs the programmed timed events and displays the ideal gain table at the end of the run (see the next figure). Use the arrow keys to advance through the table.

The run timer is automatically stopped and reset when running under Empower or Millennium<sup>32</sup> control. In standalone mode, the detector runs for an unspecified duration, so you must stop the run by pressing Run/Stop, and then select Reset (Shift, Stop) on the detector's front panel.

## Results in the auto-optimize gain table

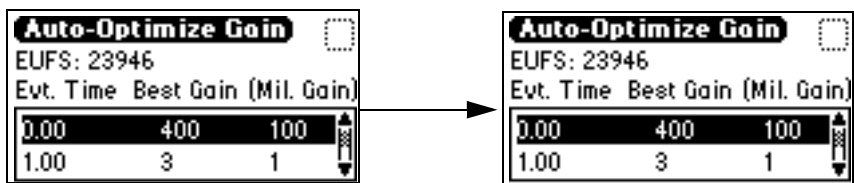

Auto-Optimize Gain		
EUFS: 23946		
Evt. Time	Best Gain (Mil. Gain)	
0.00	400	100
1.00	3	1

Once you clear the display by pressing home, the auto-optimize gain diagnostic test is automatically disengaged. With the proper gains and EUFS values specified in the method, the chromatogram is on scale.

## Gain and EUFS optimally set

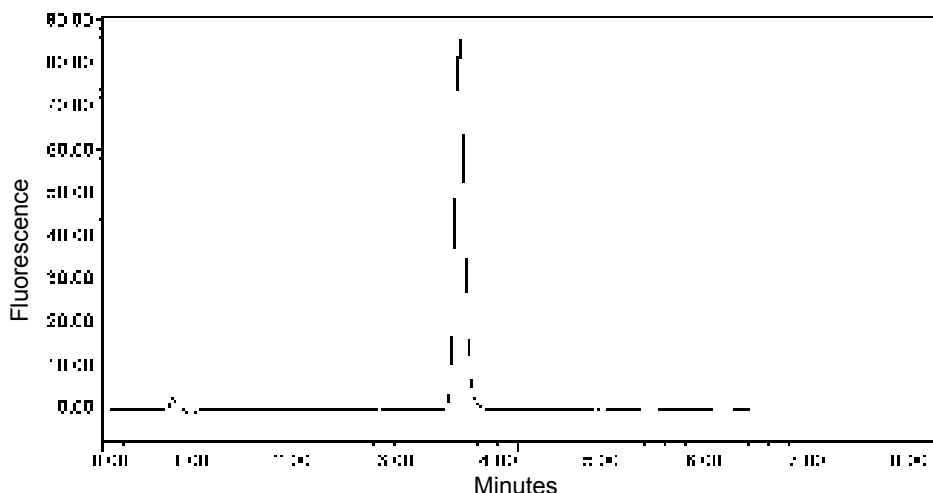

## Programming methods and events

---

### Storing methods

You can store and retrieve up to ten methods. The detector designates stored methods as the numerals 1 through 10. If you are using a stored method during operation, the method number appears on the home screen (see the [figure “Finding parameters in the fluorescence home screen” on page 3-4](#)). An asterisk in the method number icon (see the [table titled “2475 detector home](#)

[and message screen icons” on page 3-5](#)) indicates that conditions are not stored.

If you edit a parameter such as wavelength or EUFS, you are editing the current conditions (Method \*). You may store the method in one of the 10 available method storage slots, or you can replace the current method with one previously stored. When you retrieve a previously stored method, you replace the existing method conditions with those of the stored method.

The method number displayed on the home screen is that of the retrieved method until you make a change. Any parameter change (for example, wavelength or EUFS) alters conditions so that the original recalled method is no longer in effect, causing the method number to change to an asterisk.

On startup, the operating parameters at the time the detector was last shut down are restored. However, any timed events or thresholds associated with the method are deactivated when power is restored. Thus, on startup, an asterisk always appears inside the method icon on the home screen.

When the detector is operating under remote control by Empower or Millennium<sup>32</sup> software, the remote icon appears (see the [table titled “2475 detector home and message screen icons” on page 3-5](#)).

## Programming timed events

You can program up to 48 timed events to the nearest 0.01 minute. As you enter timed events, each new event appears at the end of the timed event list. You can specify a time that is not in sequence with the events specified previously, and the timed event list is sorted automatically when you press Next. The following table lists the twelve timed events.

### Timed event parameters

Number	Event	Units	Range or default	Specify channel
1	Excitation wavelength	nm	200 to 890	Yes
2	Emission wavelength	nm	210 to 900	Yes
<b>Tip:</b> The emission $\lambda$ setting must always be at least 10 nm above the excitation $\lambda$ setting.				

### Timed event parameters (Continued)

Number	Event	Units	Range or default	Specify channel
3	Time constant	Seconds	0: Disable filter Hamming: ( $\lambda$ ) 0.1 to 5.0, ( $\lambda\lambda$ ) 1 to 50 RC: ( $\lambda$ ) 0.1 to 99 sec RC: ( $\lambda\lambda$ ) 1 to 99 sec	Yes
4	Gain		0 to 1000	Yes
5	Sensitivity	EUFS	1 to 100,000	Yes
6	Chart mark (10% of full scale)	Does not apply	Does not apply	Yes
7	Polarity	1. - 2. +	+	Yes
8	Auto Zero	Does not apply	Does not apply	Yes
9	Lamp	1. Off 2. On	Off	No
10	Switch 1	1. High 2. Low 3. Pulse 4. Rect wave	Low	No
11	Switch 2	1. High 2. Low 3. Pulse 4. Rect wave	Low	No

### Timed event parameters (Continued)

Number	Event	Units	Range or default	Specify channel
12	Threshold	EU	-100.0 to 1100.0 EUs or variable, depending on output selection	Yes

### To program a new timed event:

1. Select METHOD (Shift, A/B).

#### Method list



2. From the method list, select 1 Timed events.  
An active field for specifying the time of the event appears.
3. Specify the time for the event.

**Tip:** When you begin, additional fields appear.

#### Timed events screen

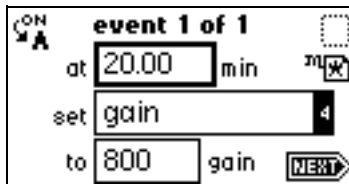

4. Press Enter. To advance to the Set field (Events list), press ▼.

5. Press Enter again to display the list. If you know the event number, simply press it (see the [table titled “Timed event parameters” on page 3-44](#)).
6. Enter the appropriate selection in the To field if the field appears.  
**Tip:** If you want the same event programmed on both channels, you must enter two events, one for channel A and one for channel B.
7. Press A/B to set the threshold on the other channel.  
**Tip:** ON A or ON B indicates the channel on which the event is programmed. You can program all or some events on channel A and all or some events on channel B. Event programming is time-based, not channel-specific.
8. Press Next to advance to a new timed event. To delete a timed event, press CE when the time field is active to change it to OFF.
9. Press HOME to return to the home screen, then press Run/Stop to start the method.
10. Select Reset (Shift, Run/Stop) to reset the run clock to 0.  
**Tip:** If the detector is configured with the 717plus Autosampler or other external device, the inject-start signal programmed from that device starts the method.



**Caution:** When you are working in real time, under current conditions (method \*), a power failure or shutdown causes loss of all timed or threshold events if you do not store them as a method (see [page 3-49](#)).

## Programming threshold events

You can program threshold events on channel A and channel B to control the switch contact closure outputs as when using a fraction collector. Program the switch to change when the programmed output (fluorescence/EU, energy, etc.) on the channel is above a specified threshold. The following table lists the contact closure switches you can program.

### Threshold events “Set” parameters

Number	Event
1	Set switch 1
2	Set switch 2

Below the specified threshold, program the switch parameters as in the table below.

### Threshold events “To” parameters

Number	Set to	Below threshold switch state
1	On	Off
2	Off	On
3	Pulse	Off
4	Rect wave (rectangular wave)	Off

To define the pulse period, or frequency, of a wave, see [page 3-25](#).

### To program a threshold event:

1. Select METHOD (Shift, A/B) on the keypad. The Method list appears.
2. From the method list, select 2 Threshold events.

An active field (EU) for entering the threshold appears. When you begin to enter a number in the EU field, additional fields appear.

**Tip:** The threshold event allows you to specify a threshold value (EU) that triggers a switch if the fluorescence signal intensity rises above the value you entered.



## Threshold events screen

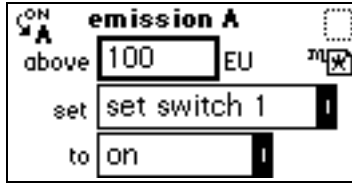

3. Press Enter to advance to the Set field, or press ▲ and ▼ to move among the three fields.
4. When the Set field is active, press Enter to display the threshold events list, or press the number corresponding to the event you are programming (see the [table titled “Threshold events “Set” parameters” on page 3-48](#)).
5. When the To field is active, press Enter to display the options shown in the [table titled “Threshold events “To” parameters” on page 3-48](#).  
As an alternative, press the number corresponding to the threshold parameter you are programming.
6. Press A/B to set the threshold on the other channel, and repeat the procedure.

## Storing a method

A method consists of all programmable parameters shown on the home and associated screens as well as timed and threshold events.

You can store the current method by selecting a location numbered 1 through 10.

### To store a method:

1. Select METHOD (Shift, A/B).
2. From the method list, select 4 Store method \*. A method number field appears.

**Tip:** No warning message appears when the method number you specify in the method number box is already assigned a previously stored method. When you enter a number and press Enter, the current method conditions are stored, overwriting any previous method stored in the same slot.

## Specifying a method number

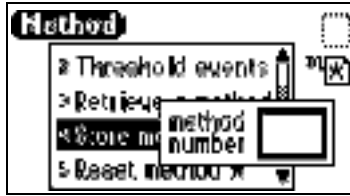

3. Specify a number from 1 through 10 and press Enter.

A brief message (“Storing \* as method *n*”) appears, and then your method number appears within the method icon. This method remains active until you retrieve another method, or reset the detector to default conditions (Method \*).

## Retrieving a method

### To retrieve a method:

1. Select METHOD (Shift, A/B).
2. From the method list, select 3 Retrieve a method.

The last method number stored or retrieved appears in the method number slot box.

3. Specify the number of the method you wish to retrieve and press Enter.

A brief message (“Retrieving method *n*”) appears, and then the method number you specified appears within the method number icon (see the [table titled “2475 detector home and message screen icons” on page 3-5](#)).

## Viewing events within a method

### To view events within a method:

1. Retrieve the method (see [page 3-50](#)).
2. Press 1 to view the Timed events or 2 to view the Threshold events.

**Tip:** If you change a timed or threshold event within a method, the asterisk appears (Method \*), indicating that the method (\*) is no longer the same as the stored method you retrieved in step 1. You can store the method containing the altered event(s) in the same storage slot.

## Resetting a method

Resetting a stored method is a two-step process. First you reset the current conditions to the defaults; then you save the defaults in a storage location.

### To reset a method:

1. Select METHOD (Shift, A/B).
2. From the method list, select 5 Reset method \*.

A message screen asks if you want to set the current conditions to the factory defaults. The [table titled “Primary and secondary function \(method\) parameters” on page 3-21](#) lists the parameter default settings. Pressing Enter at this point causes these actions in the software:

- All timed events are deleted.
- All threshold events are disabled.
- All other operating parameters ( $x\lambda$ ,  $e\lambda$ , EUFS, etc.) are set to defaults.

If you select Cancel (Shift, 0), the Method list appears.

**Tip:** To prevent loss of the current conditions before you clear the method, store them in a storage slot. When you clear the storage slots, you can restore the previous conditions.

3. Press 4 Store method, and enter a storage location number.
4. To clear other stored methods, repeat step 2.
5. When you press HOME, the method number icon has an asterisk.

## Clearing events

### To clear all active timed or threshold events:

1. Select METHOD (Shift, A/B).
2. From the method list, select 6 Clear events.

You are asked whether you want to clear all active events. Pressing Enter at this point causes these actions in the software:

- All timed and threshold events in the method are cleared.
- All other operating parameters of the method ( $\lambda$ , EUFS, etc.) are unaffected.

If you select Cancel (Shift, 0), the Method list appears.

3. When you press HOME, the method number icon has an asterisk.

## Scanning spectra

---

### Types of scanning

The detector can collect sample scans for either excitation and emission fluorescence spectra. A zero-scan is desirable initially.

- Zero-scan – A reference scan that characterizes the fluorescence spectrum of a solvent in the flow cell.
- Sample scan – An excitation or emission scan of an analyte in solvent (after subtracting the zero-scan of the solvent) to provide the actual spectrum of the sample.

The detector can measure the spectrum of a sample using the flow cell (see [page 3-64](#)) for scanning procedures.

### Before you begin

Before you run a spectrum scan, you need to specify the following parameters:

- $\lambda_1$  – Starting wavelength. Scanning begins at this wavelength.
- $\lambda_2$  – Ending wavelength. Scanning ends at this wavelength.
- Gain – The gain setting for the PMT. Sometimes, you must increase this for low sample concentrations.
- Scan Type – The type of scan (excitation or emission).
- $\lambda_{\text{other}}$  – The wavelength setting of the stationary monochromator.
- Pace – Rate of scanning in nm/min. The pace value determines how fast a scan runs and acquires data. The scan data are acquired at the highest

possible resolution for the specified pace. As shown by the following table, the higher the pace value, the poorer the resolution.

### Pace and sampling resolution examples

Pace (nm/min)	Emission sampling resolution (nm)	Excitation sampling resolution (nm)
100 and less	0.7	0.9
200	1.4	1.8
400	2.8	3.6

The following figure shows two emission scans of anthracene. At a pace of 1000 nm/min, the second scan (right) shows a reduced number of points scanned. Thus the resolution is diminished relative to that in the original scan (left) at a pace of 100 nm/min.

### Scans of anthracene at 100 nm/min and 1000 nm/min

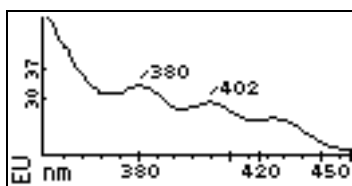

Pace = 100 nm/min

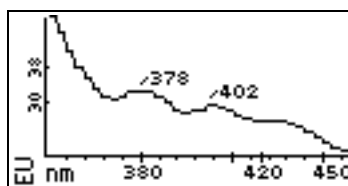

Pace = 1000 nm/min

- Tick marks – Generates tick marks at a specified wavelength interval, which helps to interpret charted data. The [figure “Scan of water without tick marks” on page 3-54](#) shows a scan of water standard in a cuvette from 390 to 455 nm at a pace of 200 nm/min without tick marks. The [figure “Scan of water with tick marks” on page 3-54](#) shows the same scan with tick marks every 20 nm.
- EUFS – The sensitivity setting for scaling the charted spectrum.

### Scan of water without tick marks

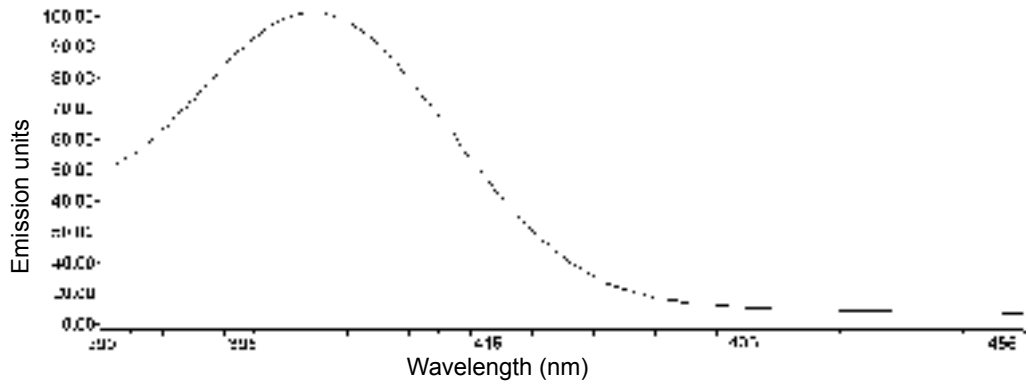

### Scan of water with tick marks

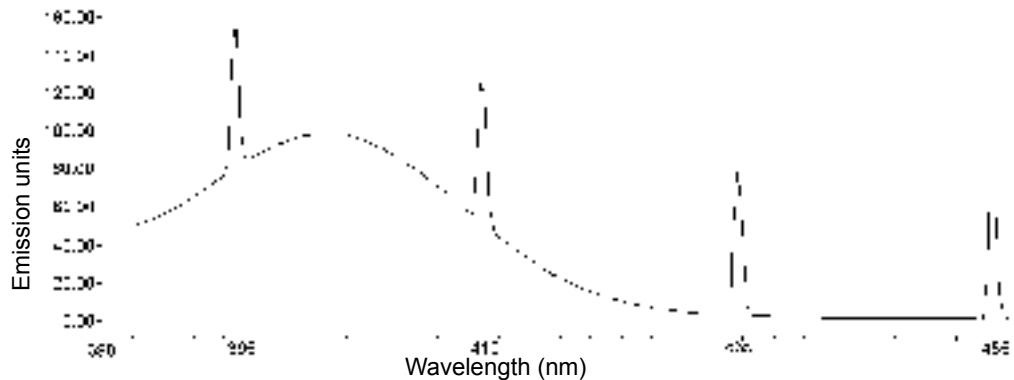

Enter scanning parameters when you select the type of scan, zero or sample. Use the detector's scan function to run a new zero or sample scan, store, review, subtract, obtain scan information, and replay.

When you select a sample or zero-scan, the detector displays three additional screens. You can change all parameter values on these screens, including starting and ending wavelengths and the pace.

## Zero and sample scan screens

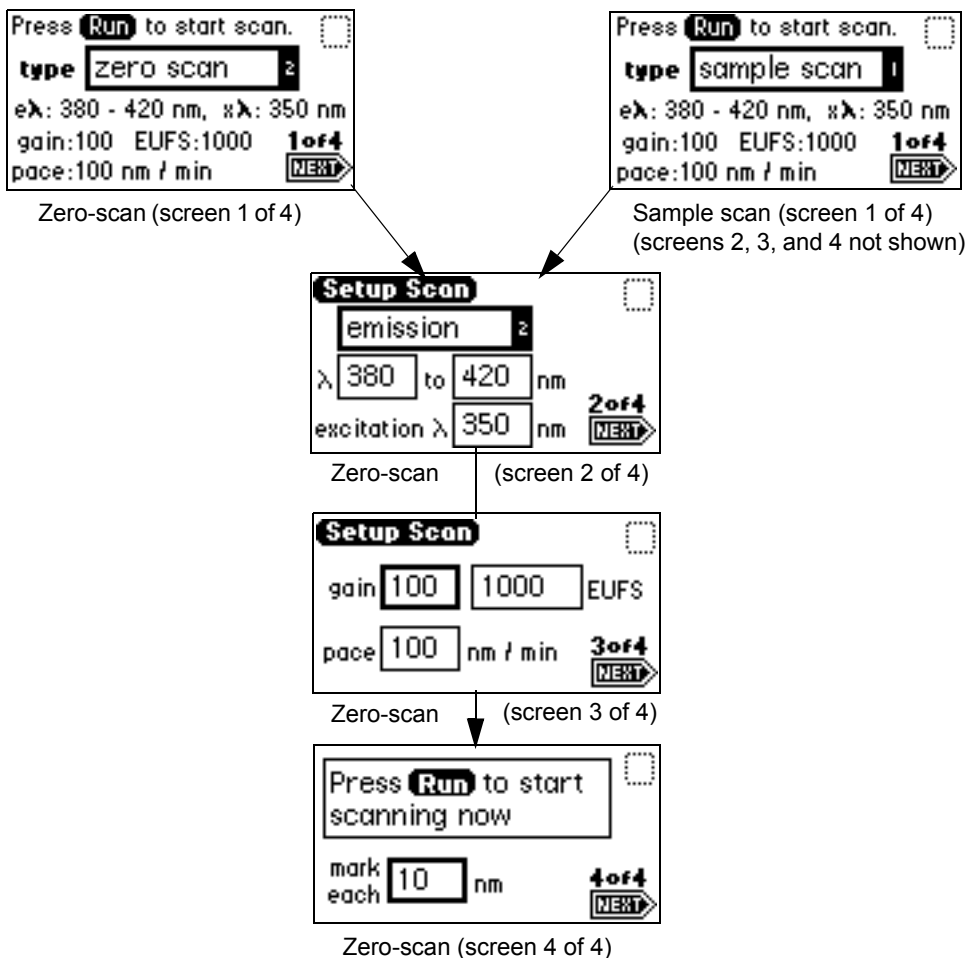

When you select a sample scan after performing a zero-scan, the detector displays one additional screen, labeled 2 of 2. Note that you cannot change the starting parameter value, ending wavelength parameter value, or the pace parameter value.

## Sample scan screens after a zero-scan

```
Press Run to start scan.
type sample scan 1
eλ: 390 - 400 nm, xλ: 350 nm
gain:10 EUFS:10000 1 of 2
pace:100 nm / min  NEXT
```

Sample scan (screen 1 of 2)

```
Press Run to start
scanning now
mark Off nm 2 of 2
each  NEXT
```

Sample scan (screen 2 of 2)

When you run the zero-scan, you specify the starting and ending wavelengths, other wavelength, pace, tick marks, and sensitivity for the zero-scan and subsequent sample scans. You must try to run sample scans within 15 minutes of the baseline zero-scan.

**Tip:** The most recent zero-scan performed or retrieved remains current until you perform or retrieve another or clear the zero-scan. The zero-scan must suit the subsequent sample scans you perform. The sample scan uses the starting and ending wavelength values and the pace value of the most recent zero-scan. Only when these parameter values are identical for both the zero and sample scans can you then subtract the zero-scan.

During a zero-scan, data are charted out via the detector analog channel A. At the same time, reference energy is charted out via channel B, at the EU specified on channel A.

During a sample scan, data are charted out via the detector analog channel A using the specified EUFS setting. At the same time, reference energy is charted out via channel B.



## Scanning new spectra

### To scan new spectra:

1. Select SCAN (Shift, Chart Mark).

### Scan list

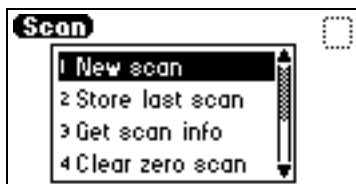

2. From the scan list, select 1 New scan, or use ▲ and ▼ to scroll through the list.

The detector displays the first of four parameter screens.

3. Press Next to advance through the New scan parameter screens.
4. On the first New scan screen, specify the type of scan:
  - For a sample scan, press 1, or press Enter to display the list.
  - For a zero-scan, press 2, or press Enter to display the list.

The detector displays three additional screens. All parameters appear on the first New scan screen for both a zero and a sample scan. You can return to screen 1 to review the parameter values for either scan type by pressing Next from the Run screen.

**Tip:** You can press Run/Stop from any New scan screen.

5. Press Run/Stop.

## Parameters used for sample and zero-scans

The following table provides the defaults and ranges for all parameters for the sample and zero-scans.

### Sample and zero-scan parameters

Parameter	Screen	Units	Range or default
Type	1	n/a	Sample scan: 1 Zero-scan: 2 Default: 1
$\lambda$ range	2	nm	Range: 200 to 900 nm Default: 200 or 210 nm
Pace	3	nm/min	Range: 30 to 1000 nm/min Default: 100 nm/min
EUFS	3	EU	Range: 1 to 100,000 Default: Last number entered
Tick mark (Mark each nm)	4	nm	Range: 10 to 100 Default: Last number entered
Gain	2	n/a	Range: 1 to 1,000
$\lambda$ other	2	nm	Default: 200 or 210 nm
Monochromator scan type	2	n/a	Excitation or emission

## Programming a zero-scan

### To program a zero-scan:

1. Select SCAN (Shift, Chart Mark).
2. Press 1 New Scan, then press 2 Zero Scan.
3. Press Next.  
The second zero-scan parameter screen appears.
4. Specify the zero-scan parameters:
  - a. Select the type of zero-scan.
  - b. Specify the starting wavelength for the zero-scan, and then press Enter.
  - c. Specify the ending wavelength for the zero-scan, and then press Enter.
  - d. Specify the wavelength for the stationary monochromator, and then press Enter.
  - e. Press Next.
5. Specify the Gain value, and then press Enter.
6. Specify the EUFS value, and then press Enter.
7. Specify a value in the Pace field for the rate at which the detector scans the specified wavelength range.  
**Tip:** The default is 100 nm/min, and the allowable range is from 30 to 1000 nm. The [figure “Scans of anthracene at 100 nm/min and 1000 nm/min” on page 3-53](#) shows two emission scans of anthracene, one at 100 nm/min and one at 1000 nm/min. The higher the number you enter in the Pace field, the lower the resolution of the scan.
8. Press Next. The fourth zero-scan parameter screen appears.
9. Specify a number from 10 through 100 nm if you want to specify tick marks, and then press Enter (see the [figure “Scan of water without tick marks” on page 3-54](#) and the [figure “Scan of water with tick marks” on page 3-54](#)). Press CE if you want to disable tick marks.

10. Press Run/Stop to start the zero-scan, or press Next, to return to the first zero-scan parameter screen to review your parameter value, and then press Run/Stop.

The Scanning screen displays a progress bar and instantaneous energy (EU).

#### Zero-scan progress bar

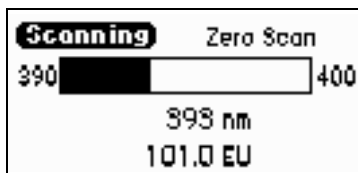

When the detector completes the zero-scan, the software returns to displaying the scan list.

## Running a sample scan

To run a sample scan:



**Caution:** Ensure your sample and mobile phase are degassed.

**Tip:** Run a zero-scan before running the sample scan. To ensure identical flow cell and solvent conditions, run the sample scan for the corresponding zero-scan within 15 minutes of running the zero-scan.

1. Set up and run the zero (or reference) scan (see [page 3-59](#)).
2. Return to the first New scan screen, and press 1 Sample Scan.

The parameters appear for wavelength range, EUFS, Pace, and wavelength for stationary monochromator (tick mark) you entered for the zero-scan.

3. Press Next to advance to the second sample scan screen.

**Tip:** If desired, you may change the entry in the Mark field.

4. Press Run/Stop to run the sample scan. A brief message (“Initializing”) appears, and the Scanning screen shows the progress of the scan, in nanometers.

A progress bar reports the degree of fluorescence, in emission or energy units (EU).

### Sample scan progress bar

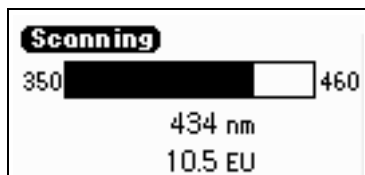

**Tip:** When you perform a zero-scan before a sample scan, the detector indicates that the zero-scan is being subtracted from the sample scan in progress.

### Subtracting the zero-scan progress bar

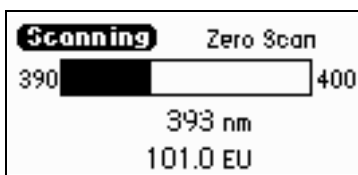

After the scan is complete, the detector displays the sample scan graphically.

### Graph of sample anthracene scan

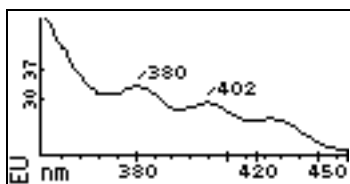

5. Press Next to display the parameters for up to three of the highest peaks scanned within the specified range.

## Highest peaks of sample anthracene scan

$\lambda$ Range: 350-450 nm	
nm	EU
1 380	33.4017
2 402	29.4665
3 422	25.6281

**NEXT** 

- Press Next to return to the graph.
- Select Scale (Shift, TRACE) to change the scale and zoom in on one section (artifact) of the spectrum. The scale of the spectrum is affected by the EUFS setting. You can alter the following four scaling parameters:
  - $\lambda 1$  – Minimum wavelength displayed.
  - $\lambda 2$  – Maximum wavelength displayed.
  - EU1 – Minimum fluorescence displayed. (The default is auto.)
  - EU2 – Maximum fluorescence displayed. (The default is auto.)
- Press Next to advance through the four scaling parameters. The following figure shows the sample from the [figure “Graph of sample anthracene scan” on page 3-61](#) after scaling the wavelength parameters to 225 and 420 nm.

## Anthracene scan with $\lambda 2$ changed to 420 nm

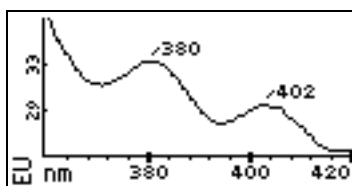

- If you change one or more scaling parameters, press Enter to reformat the graph.
- Press Next to display the properties of the highest peaks of the scaled scan.

## Highest peaks from the scaled anthracene scan

λ Range: 360-420 nm	
nm	EU
1 380	33.4017
2 402	29.4665

**NEXT** 

11. Press Next to return to the sample scan display.

To display use of the software's scaling function, the [figure "Three scans of anthracene in acetonitrile" on page 3-64](#) shows a series of scans of anthracene dissolved in acetonitrile. The zero-scan is not displayed.

For the scaling parameters, EU1 and EU2, the default is auto. You can change the EU parameter based on the fluorescence of the spectrum. To return the default to auto, press CE.

12. Select SCAN (Shift, Chart Mark) after you finish manipulating the sample scan graphical display. The scan list appears. To store the scan, see [page 3-65](#).

## Three scans of anthracene in acetonitrile

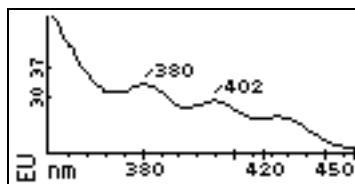

Sample emission scan 350  
to 460 nm  
Excitation=249 nm  
Anthracene

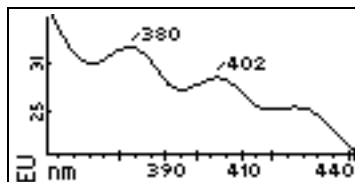

Zoom of sample emission scan  
350 to 440 nm  
20 to 35 EU  
Excitation=249 nm  
Anthracene  
 $\lambda_2$  changed to 440 nm

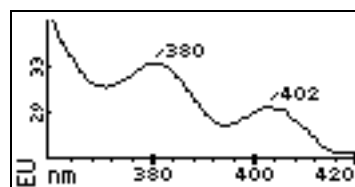

Zoom of sample emission scan  
360 to 420 nm  
Excitation=249 nm  
Anthracene  
 $\lambda_1$  changed to 360 nm  
 $\lambda_2$  changed to 420 nm  
EU1 and EU2 on auto

## Scanning using a static flow cell

### To scan using a static flow cell:

1. Use a syringe to fill the flow cell with the mobile phase or solvent in which your sample is dissolved.
2. Run a zero-scan (see [page 3-57](#)).
3. Use a syringe to fill the flow cell with the analyte.
4. Run a sample scan, keeping the pressure below 145 psi to avoid overpressuring the flow cell.
5. Use the functions storage, review, subtract and review, and replay to compare scanned data.



## Managing results

---

In standalone mode, having run a spectrum, you can store it for later review, subtraction, or playback. You can store up to five spectra (see [page 3-65](#)). You can retrieve the spectrum for purposes of reviewing it from one of the five storage slots by selecting the review function from the scan list (see [page 3-66](#)). If you store more than one spectrum, you can create a difference spectrum (see [page 3-67](#)).

**Tip:** The current spectrum is the one being subtracted from; the stored spectrum, whose slot number you enter, is the spectrum being subtracted.

You can replay the current spectrum or a stored one in real time using the real-time replay function on the scan list. The detector plays the selected spectrum in real time, both on the detector display and out the analog Detector Output 1 to the chart or data collection system. Once you retrieve a spectrum for playback, the detector displays it graphically.

### Storing a spectrum

#### To store a spectrum:

1. Select SCAN (Shift, Chart Mark) from the graph of a sample scan.
2. Press 2 Store last scan.

**Tip:** When you select store last scan, you are storing the zero-scan and the sample scan as a pair.

#### Slot number box

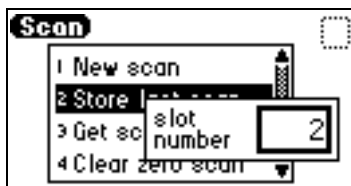

3. In the slot-number box, specify a number from 1 through 5.
4. Press Enter to store the last sample scan, paired with its zero-scan.

## Getting information about a stored spectrum

### To get information about a stored spectrum

1. Select SCAN (Shift, Chart Mark).
2. Press 3 Get scan info.

A slot number box appears, its default, Last (for the most recently stored spectrum).

3. Press Enter for information about the last stored spectrum.

As an alternative, press the number (1 to 5) of the stored spectrum about which you want information, and then press Enter. A screen containing the following information appears:

- Storage slot number – Of the selected scan (or “Last scan”)
- Scan type – Displays the chosen type of scan performed
- $\lambda$  range – Displays the wavelength range for the selected spectrum
- $\lambda$  other – The wavelength setting of the stationary monochromator
- Pace – Displays the pace for the selected spectrum
- Gain – The gain setting for the PMT (it can sometimes be necessary to increase the gain value when working with for low sample concentrations)

4. Press Enter to return to the scan list.

## Reviewing a stored spectrum

### To review a stored spectrum:

1. Select SCAN (Shift, Chart Mark).
2. Press 4 Review.

**Tip:** Selecting Review retrieves both the zero-scan and sample scan.

3. Specify the storage slot number (1 through 5) of the spectrum you want to review, and then press Enter.

**Tip:** “Retrieving spectrum *n*” appears, and then the stored spectrum appears. You can view the stored spectrum graphically, and adjust the wavelength and EU ranges, if necessary. You can also run a new sample scan based on the retrieved zero-scan.

## Creating a difference spectrum (subtracting a spectrum)

### To create a difference spectrum:

1. Select SCAN (Shift, Chart Mark).
2. Press 5 Subtract & Review.

**Tip:** To subtract one spectrum from another, the starting and ending wavelengths ( $\lambda_1$  and  $\lambda_2$ ) and the pace of both spectra must be identical.

3. Specify the storage slot number (1 through 5) of the spectrum you want to subtract from the current (or retrieved) spectrum, and then press Enter.

The message “Subtracting spectrum *n*” appears. The detector reviews and subtracts the spectrum specified from the current spectrum and, after a brief wait, displays the difference spectrum. You can store the results in one of the five storage slots.

## Replaying a spectrum

### To replay a spectrum:

1. Select SCAN (Shift, Chart Mark).
2. Press 6 Real-time replay.
3. Specify the storage slot number (1 through 5) of the spectrum you want to play back, and then press Enter.

**Tip:** The default is the last spectrum acquired.

After a pause to retrieve the selected spectrum, the detector plays the spectrum on the analog connection, and then the spectrum graph appears.

## Conserving lamp life

---

To conserve the lamp without shutting down the detector, you can leave the instrument on and extinguish the xenon lamp in these ways:

- Manually
- By programming a timed event
- By using the external contact closure

If the detector is operating under remote control, you can program the controller to extinguish the lamp without using the detector's front panel.

**Tip:** You should extinguish the lamp only if the lamp will remain unlit more than 4 hours.

Use the Lamp key to light and extinguish the lamp manually. When the lamp is unlit, the home screen displays the words "Lamp off," and an "X" is superimposed on the lamp icon.

Select the Lamp key (Shift, 1) to extinguish or light the lamp manually and to display the lamp's usage statistics.

## Manually extinguishing the lamp

### To manually extinguish the lamp:

1. Select Lamp (Shift, 1). The lamp control screen appears.

#### Lamp control screen



2. Select Lamp (Shift, 1) again to extinguish it. The home screen appears with an X through the lamp indicator icon and the words "Lamp off".

## Lamp off/on sequence

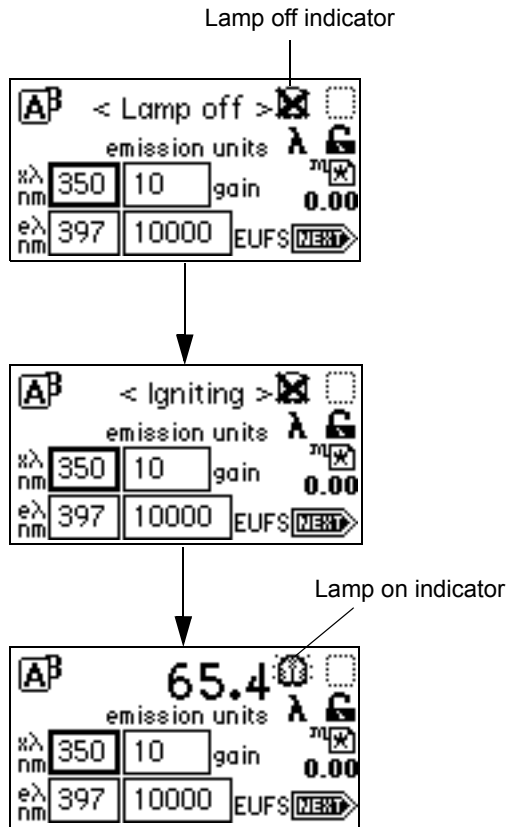

## Manually lighting the lamp

### To manually light the lamp:

1. Select Lamp (Shift, 1).

The lamp control screen appears with 0 hours and 00 minutes in the "Lamp has been on" field.

2. Select Lamp (Shift, 1) again to light the lamp.

**Tip:** When the lamp is lit, the "X" no longer covers the lamp icon on the home screen.

## Using a timed event method to program the lamp

You can conserve lamp life by programming it to light and extinguish (for example, overnight) using a timed event method. To program the lamp, select Timed events in the Method list, or program it through one of the external contact closures. See [“Programming methods and events” on page 3-43](#) and the [table titled “Timed event parameters” on page 3-44](#) for more information on programming the lamp to turn on or off using a timed event. See [“Configuring event inputs and contact closures” on page 3-25](#) for more information on programming the lamp through the external contact closure.

## Shutting down the detector

---

Before you shut down the detector, you must remove any buffered mobile phase present in the fluid path.



**Caution:** To avoid damaging to your column, remove it before you perform the following procedure.

### To shut down the detector:

1. Remove buffered mobile phase from the fluid path, replace it with 100% HPLC-quality water, and flush the system for 10 minutes at 3 mL/min.
2. Replace the water mobile phase with a solution of 90:10 methanol/water, and flush the system for 10 minutes at 2 mL/min.
3. Follow the manufacturer’s recommended procedures for injector purging and pump-priming.
4. To shut down the detector, press the on/off switch on its front, lower-right-hand corner.

# 4

## Maintenance Procedures

### Contents:

Topic	Page
Contacting Waters technical service	4-2
Maintenance considerations	4-2
Routine maintenance	4-3
Inspecting, cleaning, and replacing the flow cell	4-5
Replacing the lamp	4-8
Replacing the fuses	4-14
Cleaning the instruments exterior	4-15

## Contacting Waters technical service

---

If you are located in the USA or Canada, report malfunctions or other problems to Waters Technical Service (800 252-4752). Otherwise, phone the Waters corporate headquarters in Milford, Massachusetts (USA), or contact your local Waters subsidiary. Waters' site includes phone numbers and e-mail addresses for Waters locations worldwide. Visit [www.waters.com](http://www.waters.com), and click About Waters > Worldwide Offices.

When you contact Waters, be prepared to provide this information:

- Nature of the symptom
- Instrument serial number
- Solvent(s)
- Method parameters (sensitivity and wavelength)
- Type and serial number of column(s)
- Sample type
- Empower software version and serial number

For complete information on reporting shipping damages and submitting claims, see the document *Waters Licenses, Warranties, and Support Services*.

## Maintenance considerations

---

### Safety and handling

Observe these warning and caution advisories when you perform maintenance operations on your detector.



**Warning:** To prevent injury, always observe Good Laboratory Practices when you handle solvents, change tubing, or operate the system. Know the physical and chemical properties of the solvents you use. See the Material Safety Data Sheets for the solvents in use.





**Warning:** Avoid electric shock:

- Do not open the detector cover. The components within are not user-serviceable.
- Power-off and unplug the detector before performing any maintenance operation on the instrument.



**Caution:** To avoid damaging electrical parts, never disconnect an electrical assembly while power is applied to the detector. To interrupt power to the detector, set the power switch to Off, and then unplug the power cord from the AC outlet. Wait 10 seconds thereafter before you disconnect an assembly.



**Warning:** Using incompatible solvents can cause severe damage to the instrument and injury to the operator. Refer to [Appendix C](#) for more information.

## Spare parts

Replace only the component parts mentioned in this document. See the Waters Quality Parts Locator on the Waters Web site's Service/Support page.

## Routine maintenance

---

For sustained optimal performance, the 2475 detector requires minimal routine maintenance:

1. Replace the HPLC system's solvent reservoir filters regularly.
2. Filter and degas solvents to prolong column life, reduce pressure fluctuations, and decrease baseline noise.
3. Flush buffered mobile phases from the detector with HPLC-grade water followed by a 5 to 10% methanol solution each time the detector is shut down.

**Tip:** Flushing prevents the following problems:

- Plugging of the solvent lines and flow cell
- Damage to various components
- Microbial growth

## Removing the front-left-hand panel cover



### Caution:

- Because no user-serviceable parts are housed inside the detector, never remove the top cover. However, some procedures require you to remove the front-left-hand panel cover.
- To maintain optimum system performance, be sure to refit the front-left-hand front panel cover before resuming normal operation.

### To remove the front-left-hand panel cover:

1. Pull the bottom of the cover away from the detector gently, all the while holding on to the cover's top.
2. Withdraw the top of the cover gently, and store the cover nearby.

### 2475 detector with the front-left-hand panel cover removed

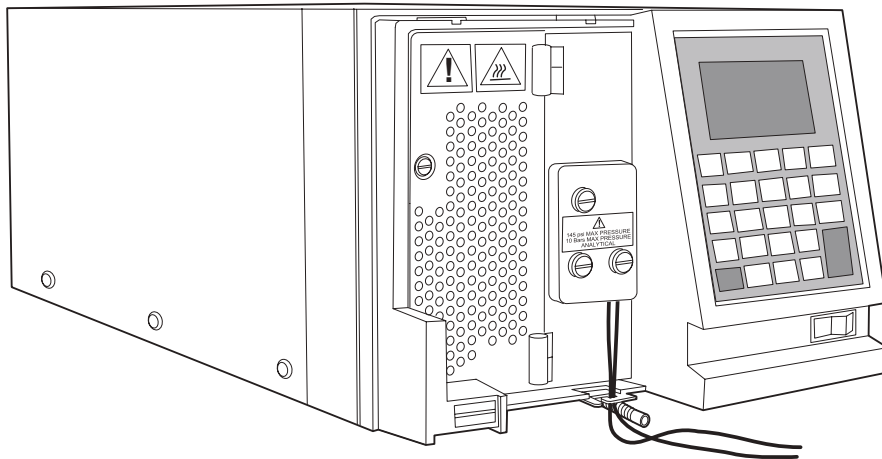

## Inspecting, cleaning, and replacing the flow cell

---

A dirty flow cell can cause baseline noise, decreased sample energy levels, calibration failure, and other problems. This section provides information about the following procedures:

- Flushing the flow cell
- Removing and cleaning the flow cell
- Replacing the flow cell

### Flushing and passivating the flow cell

Flush and passivate the flow cell when you suspect that it is dirty.

#### To flush and passivate the flow cell:

1. Discontinue the flow of mobile phase.
2. Remove the column.
3. Attach tubing from the detector to the injector outlet (from which the column has been removed).
4. Flush the mobile phase from the detector with a miscible solvent and water (unless the mobile phase is miscible with water).
5. Flush the detector with HPLC-quality water to remove contaminants from the flow path.
6. Pump 6 N nitric acid through the flow cell to clean and remove any accumulated oxides from the internal pathways (passivation).
7. Flush with HPLC-quality water until the cell is pH-neutral.
8. Reattach the column.
9. Resume mobile phase flow.

**Requirement:** Use an intermediary solvent if you are using a mobile phase that is not miscible with water.

## Removing the flow cell assembly

### To remove the flow cell assembly:

1. Shut down the detector.
2. Flush and dry the flow cell (see [page 4-5](#)), and then disconnect and cap the inlet and outlet LC tubing.
3. Remove the front-left-hand panel cover.
4. Use a 1/4-inch, flat-blade screwdriver to loosen the three captive screws on the flow cell assembly front plate.

### Unscrewing the flow cell assembly's captive screws

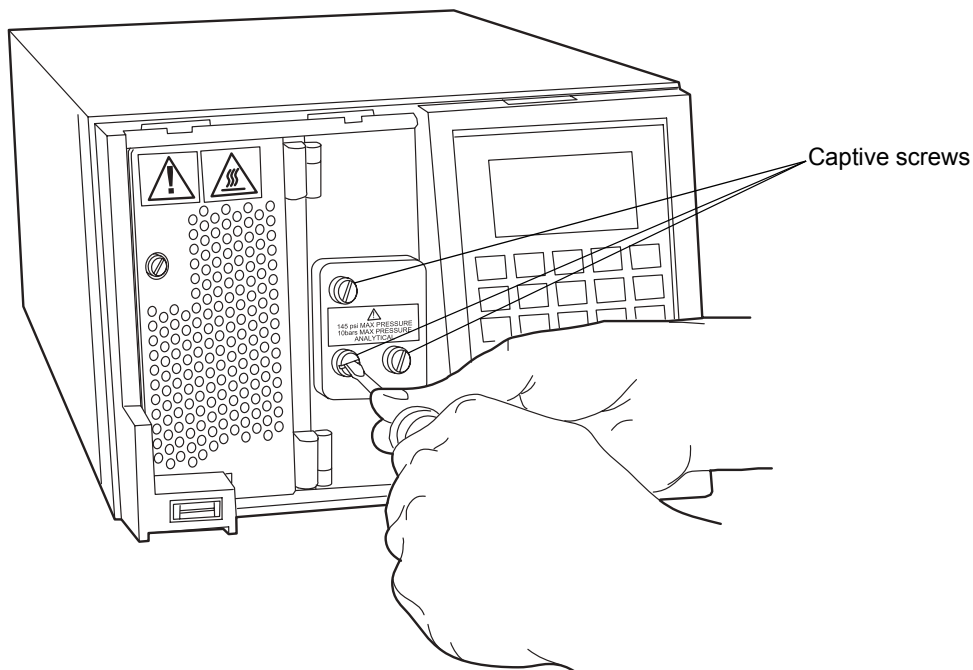

5. Pull the assembly gently toward you, tilting the bottom of the cell upward to avoid disturbing the cell mask.

### 2475 detector flow cell assembly

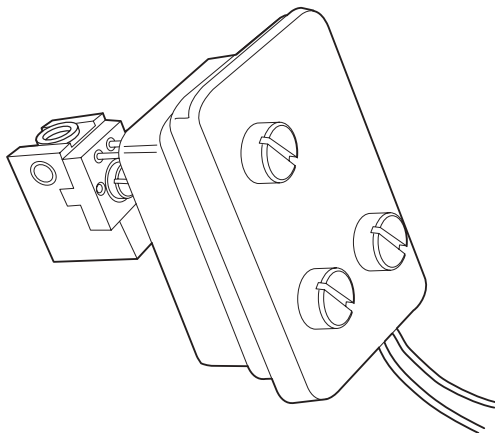

6. Place the flow cell assembly on a flat clean surface.

## Replacing the flow cell

The detector is shipped with a standard analytical flow cell installed. Replace the flow cell when it becomes damaged.

### Before you begin:

1. Unpack and inspect the new flow cell.
2. Shut down the detector.
3. Remove the front-left-hand panel cover.
4. Disconnect the detector inlet/outlet tubing from the main column connection and cap.

### To replace the flow cell:

1. Use a 1/4-inch flat-blade screwdriver to loosen the three captive screws on the flow cell assembly front plate (see the [figure “Unscrewing the flow cell assembly’s captive screws” on page 4-6](#)).
2. Pull the assembly gently toward you.

3. Insert the new flow cell assembly into the detector.
4. Tighten the captive screws.
5. Confirm that the flow cell seats properly.
6. Reconnect the inlet/outlet tubing.
7. Start the detector.
8. Calibrate (see [page 3-35](#)) and normalize (see [page 3-36](#)) the detector.

## Replacing the lamp

---

This section describes the procedure for removing and replacing the xenon lamp.

The 2475 detector source lamp is warranted to light and pass startup diagnostic tests for 2000 hours or 1 year from the date of purchase, whichever comes first.



**Warning:** Always use protective eye wear when replacing a lamp.

**Tip:** Always perform the procedure on [page 3-34](#) each time you change the lamp.

## When to replace the lamp

Replace the lamp when either of these conditions applies:

- It fails to ignite on startup.
- The lamp's energy level causes a decrease in sensitivity to the point where the baseline is too noisy for your LC application.

Performance requirements and permitted tolerances vary from application to application. If the lamp no longer provides an adequate signal-to-noise ratio for your specific application, replace it.

## Removing the lamp



**Warning:** The lamp housing becomes extremely hot during lamp operation. To prevent burn injuries,

- allow the lamp to cool for 60 minutes before removing it.
- keep the lamp in the housing when handling the lamp.



**Warning:** To avoid eye injury from ultraviolet radiation exposure,

- power-off the detector before changing the lamp.
- wear eye protection that filters ultraviolet light.
- keep the lamp in the housing during operation.

### To remove the lamp:

1. Power-off the detector and disconnect the power cable from the rear panel.



**Warning:** The lamp and lamp housing can be hot. Wait 60 minutes after powering off the detector for these components to cool before touching them.

2. Allow the lamp to cool for at least 60 minutes.
3. Remove the front-left-hand panel cover.
4. Open the lamp access door with a small flat-blade screwdriver.



**Caution:** Do not grasp the connector by the wire. Doing so could damage the connector or cable.

5. Disconnect electrical connections to the lamp:
  - a. Pull the top connector straight out, gently.

- b. Pinch the locking mechanism on the bottom connector before pulling it out.

### Unplugging the lamp assembly

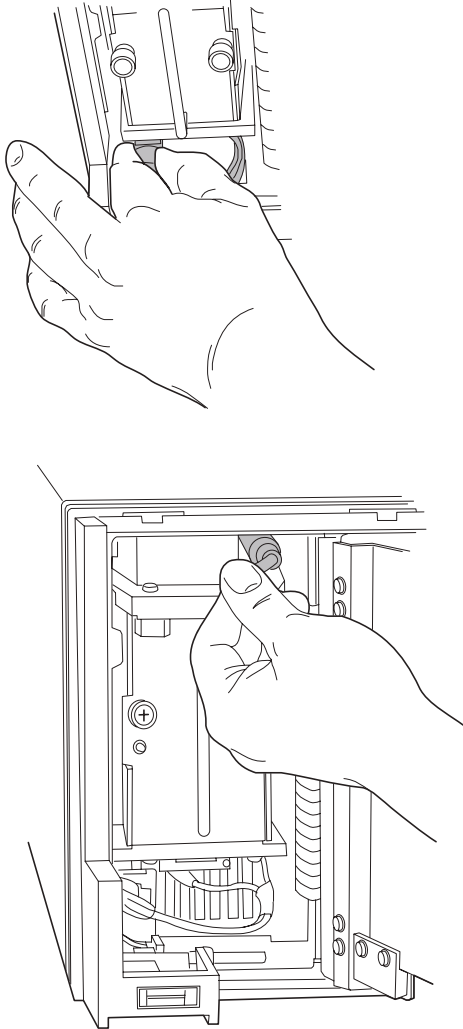



6. Loosen the two captive screws on the lamp housing.



**Warning:**

- To avoid injury, always keep the lamp facing away from you when removing it.
- Lamp gas is under positive pressure. To prevent shattering the glass, use care when disposing of the lamp. Waters suggests that you adequately cushion an old lamp by containing it in the packaging of its replacement before you dispose of it.

7. Gently pull the lamp out.

### Removing the lamp assembly

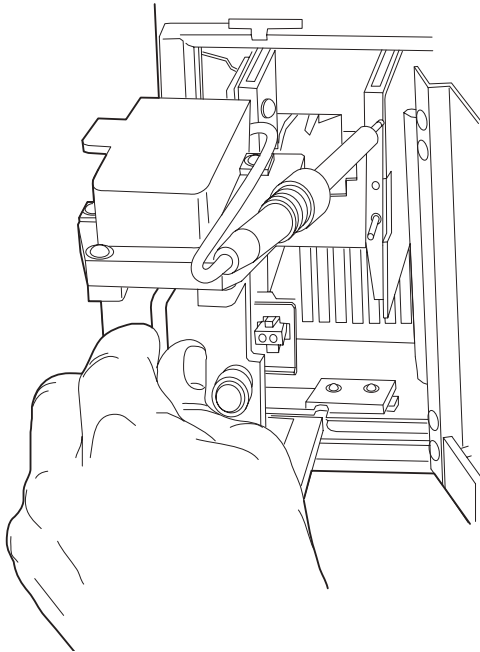

## Installing the new lamp



**Warning:** To avoid exposing your eyes to harmful ultraviolet radiation, wear eye protection that filters ultraviolet light, and keep the lamp in the housing during operation.



**Caution:** Do not touch the glass bulb on the new lamp. Dirt or skin oils on the bulb affect detector operation. If the lamp needs cleaning, gently clean the bulb with ethanol and lens tissue. Do not use any abrasive tissue or apply excessive pressure.

### Before you begin:

1. Unpack the lamp from its packing material.
2. Record the serial number, which is located on a label attached to the lamp's connector wire, following the procedure on [page 4-13](#).



**Warning:** Make sure electrical power to the detector is off and the power cord is disconnected.

### To install the new lamp:

1. Position the lamp cartridge, and insert it in the housing.  
**Tip:** No additional alignment is required.
2. Push the lamp forward gently, until it bottoms into position.
3. Tighten the two captive screws.
4. Reconnect the lamp's power connectors.

**Tip:** The bottom connector locks into place.

5. Close and secure the lamp access door.
6. Connect the power cord, and start the detector.

Allow at least 60 minutes for the lamp to warm before resuming operations.

7. Record the new lamp's serial number (see the next section).

## Recording the new lamp's serial number

**Tip:** If you do not record a new lamp's serial number, the date of the previous lamp installation remains in the detector's memory, voiding the new lamp's warranty.

Using the detector software, you can record and store the serial number and date of installation of a new lamp so that you can monitor the age of the lamp and its number of ignitions.

### To record the new lamp serial number:

1. Once the unit warms, press DIAG.
2. Press 4 Lamp, display & keypad.
3. Press 1 Change lamp.

**Tip:** Be sure to enter the lamp's serial number and not its part number when performing this procedure.

4. Specify the serial number of the new lamp in the active field.

**Tip:** This field accepts numeric entries only.

### Change lamp screen



The screenshot shows a screen titled "Change Lamp" with a cursor in the top right corner. Below the title is the label "serial number of new lamp:" followed by a text input field containing the number "12046". Below that is the label "date installed:" followed by three input fields: a dropdown menu showing "Jul", a text field containing "04", and a text field containing "01".

5. Press Enter to store the serial number and move to the "date installed" field.
6. Select the current month from the list.
7. Press Enter twice to update the month and move to the day field.
8. Specify the number for the day of the month you installed the lamp, and then press Enter to enter the date and move to the year field.
9. Specify the year (last two digits only), and then press Enter.
10. Press HOME.

The "OK to store" message appears.

## Lamp serial number OK to store message



11. Press Enter if the serial number and date of installation of the new lamp are correct.
12. Press Enter at the confirmation message.
13. Perform a manual wavelength calibration (see [page 3-35](#)).
14. Perform a normalization procedure (see [page 3-36](#)).

## Replacing the fuses

---



**Warning:** To avoid electric shock, power-off and unplug the 2475 detector before examining the fuses. For continued protection against fire, replace fuses with those of the same type and rating only.

The detector requires two 100 to 240 VAC, 50 to 60-Hz, F 3.15-A, 250-V (fast-blow), 5 × 20 mm (IEC) fuses.

Suspect a fuse is open or otherwise defective when

- the detector fails to power-on.
- the display is blank.
- the fans do not operate.

### To replace the fuses:

Replace both fuses, even when only one is open or otherwise defective.

1. Power-off the detector and disconnect the power cord from the power entry module.
2. Insert the tip of a small flat-blade screwdriver into the fuse holder slot on the rear panel of the detector. With minimum pressure, pull on the spring-loaded fuse holder and remove it from the rear panel.

## Removing and replacing the rear panel fuses

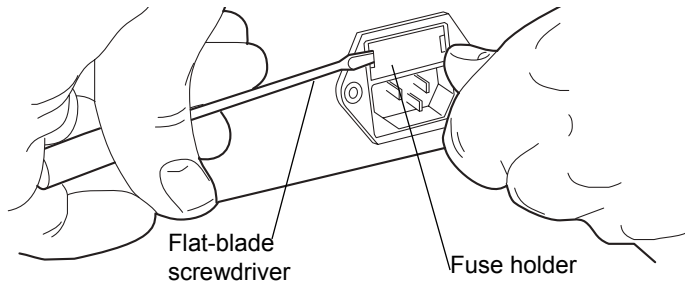

3. Remove and discard the old fuses.
4. Make sure that the ratings of the new fuses suit your requirements.
5. Insert the new fuses into the fuse holder.
6. Insert the fuse holder into the receptacle, and gently push until it locks into position on the rear panel.
7. Start the detector.

## Cleaning the instruments exterior

---

Use a soft cloth, dampened with water, to clean the outside of the detector.



# 5

## Error Messages, Diagnostic Tests, and Troubleshooting

The detector provides both user and service diagnostics to troubleshoot system problems.

Only qualified Waters Service personnel can access the service diagnostics.

- Error messages – Startup, calibration, and other error messages and recommended actions for correcting the errors.
- Diagnostic tests – User diagnostic tests for troubleshooting and configuring the detector.

### Contents:

Topic	Page
<a href="#">Startup error messages</a>	5-2
<a href="#">Operational error messages</a>	5-3
<a href="#">User-selected diagnostic tests and settings</a>	5-8
<a href="#">Troubleshooting</a>	5-20

## Startup error messages

---

Startup diagnostic tests verify the proper operation of the electronics. If one or more of the internal diagnostic tests fails, the detector beeps and displays an error message. For serious errors, <Error> appears on the home screen instead of the runtime.

**Tip:** To prevent errors at startup, be sure the flow cell contains degassed transparent solvent (methanol or water) flowing at 1 ml/min, and the front-left-hand panel cover is attached securely.

The following table lists the startup messages with descriptions and corrective actions in alphabetical order. [“Wavelength verification and test” on page 1-14](#), [“Verifying the detector” on page 3-34](#), and [“Manual wavelength calibration” on page 3-35](#) have verification and calibration information and procedures.

### Startup error messages

Error message	Description	Corrective action
Calibration differs: <i>n.n</i> nm	At startup, the unit performs a complete verification and measures all calibration points. New calibration points are compared to stored points from the most recent manual calibration. This message appears when any point differs by more than 2.0 nm.	<ul style="list-style-type: none"><li>• Cycle power (shut down, wait 10 seconds, then restart).</li><li>• Perform manual calibration.</li><li>• Contact Waters Technical Service.</li></ul>
Calibration not found	Stored calibration data not valid.	Perform manual calibration procedure.
Calibration unsuccessful: Peak out of range <i>n.n</i> nm	Results of a calibration operation outside of specification. Unit uses previously stored calibration.	<ul style="list-style-type: none"><li>• Flush flow cell with water.</li><li>• Replace lamp.</li></ul>



## Startup error messages (Continued)

Error message	Description	Corrective action
Lamp external input conflict	A timed event or front panel action attempts to change the lamp state in conflict with enabled lamp input contact closure.	<ul style="list-style-type: none"> <li>• Check contact closure status.</li> <li>• Check timed events.</li> <li>• Cycle power.</li> </ul>
Lamp failure	Lamp indicates Off when it should indicate On	<ul style="list-style-type: none"> <li>• Check lamp icon.</li> <li>• Cycle power.</li> <li>• Replace lamp.</li> </ul>
Lamp lighting failure	The lamp failed to ignite	<ul style="list-style-type: none"> <li>• Cycle power.</li> <li>• Check lamp power connection.</li> <li>• Replace lamp.</li> </ul>
Peak not found: Erbium <i>n</i> nm	No local maximum in the erbium filter calibration range	<ul style="list-style-type: none"> <li>• Flush flow cell with water.</li> <li>• Replace lamp.</li> </ul>

## Operational error messages

During initialization, calibration, and operation, the home screen may sometimes display “<Error>”. This type of error is usually catastrophic, preventing further operation, halting the fluorescence output, and suspending the display. In most cases, you can cycle power (shut down, wait 10 seconds, then restart) to correct the error. However, if the error persists, contact Waters Technical Service (see [page 4-2](#)).

### Catastrophic error display on the home screen

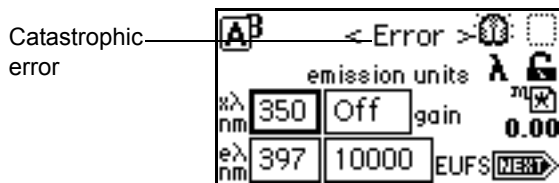

If a catastrophic error appears

1. Ensure that the flow cell is clean.
2. Ensure that the lamp access door is shut securely.
3. Recycle power to the detector.
4. If the catastrophic error persists, contact Waters Technical Service (see [page 4-2](#)).

The following table has error messages that prevent operation, listed in alphabetical order.

### Error messages preventing operation

Error message	Description	Corrective action
Communication failure: Reference A/D	A/D communication test failed.	<ol style="list-style-type: none"> <li>1. Power-off and power-on again.</li> <li>2. If the problem persists, call Waters Technical Service.</li> </ol>
Communication failure: Sample A/D	A/D communication test failed.	<ol style="list-style-type: none"> <li>1. Power-off and power-on again.</li> <li>2. If the problem persists, call Waters Technical Service.</li> </ol>
Configuration not found	Stored configuration data is invalid.	Power-off and power-on again.
Dark current too high: <i>nnnnnnn</i>	The dark energy level is above 1000000.	<ol style="list-style-type: none"> <li>1. Power-off and power-on again.</li> <li>2. If the problem persists, call Waters Technical Service.</li> </ol>
Dark current too low: 0	The dark energy level equals 0.	<ol style="list-style-type: none"> <li>1. Power-off and power-on again.</li> <li>2. If the problem persists, call Waters Technical Service.</li> </ol>

## Error messages preventing operation (Continued)

Error message	Description	Corrective action
Electronic A/D failure	Lamp optimization is adjusted at the minimum level.	Power-off and power-on again.
	Data acquisition via A/D converters is interrupt-driven. If interrupt is too long, problem with data acquisition is indicated.	<ol style="list-style-type: none"> <li>1. Power-off and power-on again.</li> <li>2. If the problem persists, call Waters Technical Service.</li> </ol>
Filter initialization failure: Erbium position	Unit sensors cannot find erbium filter position.	<ol style="list-style-type: none"> <li>1. Ensure solvent is flowing.</li> <li>2. If the problem persists, power-off and power-on again.</li> <li>3. If the problem persists, call Waters Technical Service.</li> </ol>
Filter initialization failure: Order filter position	Unit sensors cannot find the order filter position.	<ol style="list-style-type: none"> <li>1. Ensure solvent is flowing.</li> <li>2. If the problem persists, power-off and power-on again.</li> <li>3. If the problem persists, call Waters Technical Service.</li> </ol>
Filter initialization failure: No filters found	Unit sensors observe transition to dark before homing the optical filter.	<ol style="list-style-type: none"> <li>1. Ensure solvent is flowing.</li> <li>2. If the problem persists, power-off and power-on again.</li> <li>3. If the problem persists, call Waters Technical Service.</li> </ol>

## Error messages preventing operation (Continued)

Error message	Description	Corrective action
Filter initialization failure: No reference energy	Unit sensors cannot find any light energy before homing the optical filter.	<ol style="list-style-type: none"> <li>1. Ensure solvent is flowing.</li> <li>2. If the problem persists, power-off and power-on again.</li> <li>3. If the problem persists, call Waters Technical Service.</li> </ol>
Filter initialization failure: No response	Unit sensors cannot identify any dark regions.	<ol style="list-style-type: none"> <li>1. Ensure solvent is flowing.</li> <li>2. If the problem persists, power-off and power-on again.</li> <li>3. If the problem persists, call Waters Technical Service.</li> </ol>
Filter initialization failure: Shutter position	Unit sensors cannot find the shutter position.	<ol style="list-style-type: none"> <li>1. Ensure solvent is flowing.</li> <li>2. If the problem persists, power-off and power-on again.</li> <li>3. If the problem persists, call Waters Technical Service.</li> </ol>
Grating initialization failure: Backlash too high	The difference between the forward and reverse peak positions of special features is greater than 1 step.	<ol style="list-style-type: none"> <li>1. Ensure solvent is flowing.</li> <li>2. If the problem persists, power-off and power-on again.</li> <li>3. If the problem persists, call Waters Technical Service.</li> </ol>

## Error messages preventing operation (Continued)

Error message	Description	Corrective action
Grating initialization failure: No home sensor	Search for the home sensor failed.	<ol style="list-style-type: none"> <li>1. Power-off and power-on again.</li> <li>2. If the problem persists, call Waters Technical Service.</li> </ol>
Hardware failure: lamp relay cannot open!	The lamp failed to extinguish when the door or thermal switch were opened.	Close the lamp door, and contact Waters Technical Service.
Lamp data not found	Stored lamp data are not valid.	Power-off and power-on again.
Lamp is disabled	The lamp door or thermal switch is open.	<ol style="list-style-type: none"> <li>1. Close the lamp door.</li> <li>2. Remove any cooling vent obstructions.</li> <li>3. If the problem persists, call Waters Technical Service.</li> </ol>
Method not found	Stored method data is not valid.	Power-off and power-on again.
PMT not calibrated	No valid gain settings are saved in the battery-backed memory of the CPU.	Call Waters Technical Service.
Sample signal is saturated. Gain set too high.	Emission signal has overloaded PMT electronics.	<ol style="list-style-type: none"> <li>1. Reduce gain.</li> <li>2. Reduce sample concentration or background fluorescence.</li> <li>3. Use PMT sensitivity diagnostic test.</li> </ol>
Scan not found	Stored scan data are not valid.	Power-off and power-on again.

## Error messages preventing operation (Continued)

Error message	Description	Corrective action
System cannot respond	Error occurs while unit is positioning next wavelength or changing modes during initialization or calibration.	<ol style="list-style-type: none"><li>1. Power-off and power-on again.</li><li>2. If the problem persists, call Waters Technical Service.</li></ol>
System not calibrated	The calibration read from nonvolatile memory is not valid.	<ol style="list-style-type: none"><li>1. Power-off and power-on again.</li><li>2. If the problem persists, call Waters Technical Service.</li></ol>
Units not normalized	No valid normalization constants are saved in the battery-backed memory of the CPU.	Run the normalization function (see <a href="#">page 3-36</a> ).

## User-selected diagnostic tests and settings

---

**Tip:** The detector uses both user-selectable and service diagnostic tests and settings. Only qualified Waters Service personnel can access service diagnostic tests.

### Overview of diagnostic tests and settings

You may operate several diagnostic tests and settings for use in troubleshooting the detector and verifying proper functioning of the detector's electronics and optics.

### Performing tests and changing settings

**To perform the tests and change settings:**

1. Press DIAG on the keypad. The Diagnostics list appears.

## Test and settings list

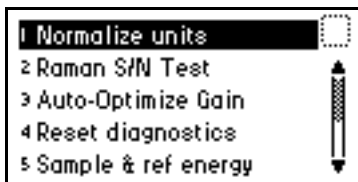

2. Use ▲ or ▼ to select the test you want to run or setting you want to change, and press Enter, or press a number from 1 through 8. Choices that display other choices are indicated by >> (see the [table titled “2475 detector diagnostic tests and settings” on page 5-10](#)).

## Sticky diagnostic settings

Sticky diagnostic settings remain in effect until you disable them. When a sticky diagnostic test is active, the home screen displays a wrench icon. If no tests are active, the wrench icon does not appear on the home screen.

## Home screen showing active sticky diagnostic settings

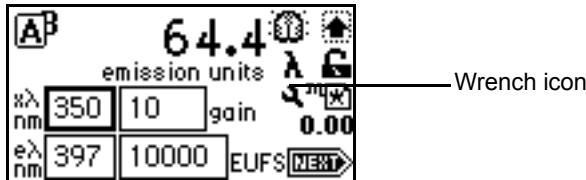

- To disable a specific sticky diagnostic setting, reset it to the default settings.
- To disable all active sticky diagnostic settings, press DIAG, then press 4 Reset diagnostics.
- When you shut down the detector, all sticky diagnostic settings are disabled.

You can select the following sticky diagnostic settings:



- Auto-optimize gain
- Fix EU [Fix (set) fluorescence input]
- Fix voltage [Fix (set) voltage outputs]
- Generate test peaks

- Optical filter override

**Tip:** Sticky diagnostic settings remain in effect even after you exit the diagnostic function and can affect results. Press 4 Reset diagnostics from the test list or shut down the detector to clear changes to the voltage output or fluorescence input or to make a manual optical filter change.

The following table lists the diagnostic tests and settings by number with a brief description.

### 2475 detector diagnostic tests and settings

Diagnostic	Description
1 Normalize Units	Normalizes the emission units of the detector to 100 EU using a standard clean water reference.
2 Raman S/N Test	Runs the 15 minute signal-to-noise test for water.
3 Auto-Optimize Gain 	Displays a table of recommended gain settings for a method based on a trial sample injection.
4 Reset diagnostics	Resets all diagnostic tests to defaults. Disables sticky diagnostic tests and removes the wrench icon.
5 Sample & ref energy	Allows you to view sample and reference energy (displayed in nanoAmps) on channel A or B.
6 Input & output >>	List of diagnostic tests that control four contact closure inputs and two switch outputs: 1 Auto-zero offsets 2 Fix EU  3 Fix voltage  4 Contact closures & events 5 Previous choices <<
7 Lamp, display & keypad >>	List of diagnostic tests for the lamp, display, and keypad functions: 1 Change lamp 2 Test keypad 3 Test display 4 Previous choices <<



## 2475 detector diagnostic tests and settings (Continued)

Diagnostic	Description
8 Other diagnostics >>	Tests that allow you to generate test peaks to determine wavelength accuracy or override the default filter setting:  1 Generate test peaks ↴  2 Optical filter override ↴  3 Previous choices <<
9 Service	Diagnostic tests used by Waters service personnel.

### Normalize units setting

See [page 1-5](#) and [page 3-36](#).

### Auto-optimize gain test

See [page 1-17](#) and [page 3-40](#).

## Sample and reference energy diagnostic tests

The sample and reference energy tests plot the output of the analog channels, to examine noise fluctuations, and to compare with the EU time trace. The current sample and reference energy readings appear in energy units from 1 to 10,000.

### Sample and reference energy tests

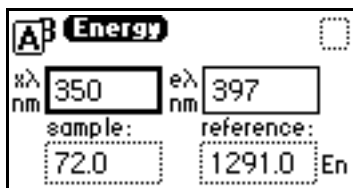

### To perform sample and reference energy tests:

1. Press DIAG, then press 5 Sample & ref energy.

2. Specify a new wavelength number to change the wavelength, and then press Enter. When the new wavelength shifts to the left, the corresponding sample and reference energies appear.
3. If you are operating the detector in multichannel mode, press A/B to view sample and reference energy on the other wavelength.

## Raman signal-to-noise test diagnostic test

The Raman signal-to-noise test evaluates the detector's signal-to-noise performance. Before running the test, run the normalize units test (see [page 3-36](#)). When you start the signal-to-noise test, the detector sets the excitation wavelength to 350 nm, it sets the emission wavelength and gain to the values stored during the normalize units test.

Clean, degassed water must be flowing through the flow cell for this test.

### To perform the Raman signal-to-noise diagnostic test:

1. Press DIAG, then press 2 Raman S/N Test.
2. Press Enter to confirm the presence of clean, degassed water.
3. Wait 15 minutes for the detector to display the results.

### Raman S/N test screen

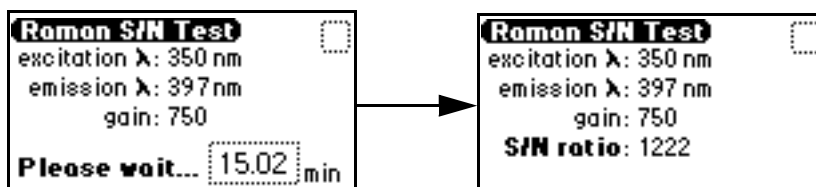

## Input and output diagnostic tests and settings

Use the input and output tests and settings for these purposes:

- Display and reset the auto-zero offsets.
- Fix (set) EU.
- Fix (set) the voltage on the 1-V output.
- Monitor contact closures and toggle event switches.
- Generate test peaks.

- Override the optical filter.

To perform one of the input and output tests or change a setting, press 6 Input & output. A list of four diagnostic tests and settings appears.

### Input and output diagnostic tests and settings

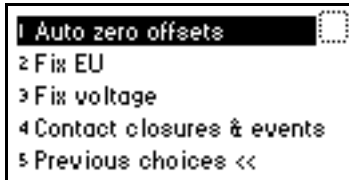

### Displaying auto-zero offsets

To display auto-zero offsets:

1. From the Input & output list, press 1 Auto zero offsets.

#### Auto-zero offsets screen

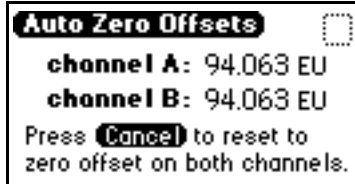

2. Select Cancel (Shift, 0) if you want to clear the offset on both channels to zero.

### Setting the fixed EU value

This function sets the voltages on the analog output channels based on the current EUFS setting.

To set the fixed EU value:

From the Input & output list, press 2 Fix EU to set a fixed fluorescence value for channel A or channel B. The allowable range is from -100.0 to +1000 EU. You can also specify sensitivity in EUFS. The allowable range is from 10 to 100,000 EUFS.

## Fix EU screen

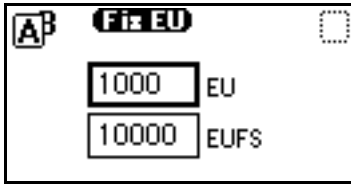

## Setting fixed voltage output

This function drives the voltage on the selected analog channel (A or B).

### To set the fixed voltage output:

From the Input & output list, press 3 Fix voltage to select a voltage for the analog output. You can select a voltage for both output channels (range -0.10 to +1.10-V).

## Fix voltage screen

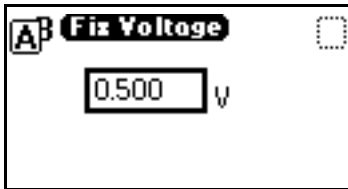

## Monitoring contact closures and setting switches

### To monitor contact closures and setting switches:

1. From the Input & output list, press 4 Contact closures & events to monitor the four contact closure inputs and to control the two switch outputs.

## Contact closures & events screen



You can monitor the state of the contact closure inputs in real time. A solid (filled in) circle indicates the contact closure is closed (ON = High). An open (empty) circle indicates the contact closure is open (OFF = Low).

2. For the outputs (SW1 and SW2)
  - a. Press Enter to display the active switch (surrounded by a dotted-line border).
  - b. Press any numerical key to change the status (from ON to OFF, or vice versa).
  - c. Press Enter to select the second switch.

## Change-lamp function

Whenever you change the lamp, use this function to enter a new serial number and installation date. See [page 4-12](#) and [page 4-13](#) for a complete explanation of the lamp replacement procedure.

**Tip:** If you do not record the new lamp's serial number using the procedure on [page 4-12](#) and [page 4-13](#), the date of the previous lamp installation remains in the detector memory, and the lamp warranty is voided.



**Caution:** Interrupt power to the detector before you replace the lamp.

### To enter a serial number and date:

1. Press DIAG, and then press 7 Lamp, display & keypad >>.
2. Press 1 Change lamp.

## Change lamp screen

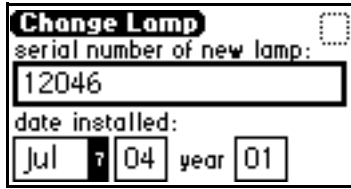

3. On the Change Lamp screen, specify the serial number, and then press Enter.  
**Tip:** Be sure to specify the lamp's serial number and not its part number.
4. Specify the date of installation for the new lamp, and then press Enter.

## Testing the keypad

### To test the keypad:

1. Press DIAG, and then press 7 Lamp, display & keypad >>.
2. Press 2 Test keypad.

### Keypad test

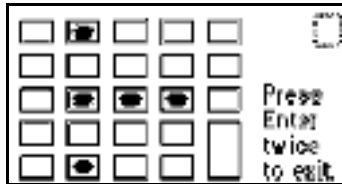

3. Press any key to begin the test, and then press each key until you try all of them.  
**Tip:** If the keypad is operating properly, each key location is filled in and then cleared with a second press of the key. If any key does not respond when pressed, contact your Waters service representative.
4. Press Enter twice to exit the keypad test.

## Testing the display

### To test the display:

1. Press DIAG, then press 7 Lamp, display & keypad >>.
2. Press 3 Test display.

The display fills from top to bottom and right to left, and then returns to the Lamp, display & keypad list. If the display does not completely fill horizontally or vertically, contact your Waters service representative.

3. Press 4 to return to the diagnostics list.

## Other diagnostic tests and settings

The Other diagnostic tests and settings screen provides three additional diagnostic functions:

- Generate test peaks – Generates test peaks to calibrate a chart recorder or data system.
- Manually override the optical filter – Selects a filter different from the one used in the detector’s normal operating mode.
- PMT Sensitivity – Reduces PMT sensitivity by a factor of 10 or 100 to avoid saturation with highly fluorescent samples and mobile phases.

Press DIAG, and then press 8 Other diagnostics. You can generate test peaks (see [page 5-17](#)) or override the optical filter (see [page 5-18](#)).

### Other diagnostic tests and settings

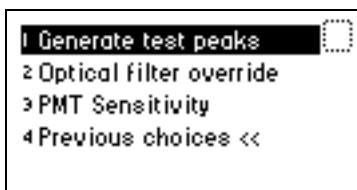

## Generating test peaks

The generate test peaks function changes the first entry on the list to “Disable test peaks.”

### To generate test peaks:

1. Press DIAG, then press 8 Other diagnostics.
2. Press 1 Generate test peaks to generate test peak.

**Tip:** Every 100 seconds, the detector generates a 100-EU peak with a standard deviation of 10 seconds on the trace, chart, or data system display. The amplitude of the test peaks is affected by your choice of filter time constant. The gain is automatically set to 1000.

### Generate test peaks message



**Tip:** You must manually disable the Generate test peaks function to stop it.

3. Press 1 Disable test peaks to stop generating test peaks.

## Overriding the optical filter setting

The detector normally operates with the filter in the Automatic position. Use this function to override the default setting.

### To override the optical filter setting:

1. Press DIAG, then press 8 Other diagnostics.
2. Press 2 Optical filter override to manually override the detector's automatic filter choice. The Optical Filter screen appears.

### Optical filter setting screen





3. Press Enter.

Automatic	1
Second Order	2
None	3
Erbium	4
Shutter	5

4. In the list of filters, press a number to the corresponding filter, or leave the default filter (Automatic) on.
5. Press DIAG, and then press 1, or select Automatic for the default filter.

## Reducing PMT sensitivity

The detector's design increases the limit of detection, but in some circumstances the photomultiplier tube can be overloaded by large fluorescence signals. You can reduce the sensitivity of the photomultiplier tube by a constant factor while preserving the available linear gain range of 1 to 1000. This feature is intended for use when samples or mobile phase solvents exhibit high fluorescence emissions that saturate the PMT signal but reducing concentration is not possible. The PMT sensitivity is divided by a user selectable factor of 10 or 100.

Unlike the ordinary PMT gain range of 1 to 1000, the reduction in PMT sensitivity is not linear, and this function should not be used as a substitute for ordinary gain changes.

### To reduce PMT sensitivity:

1. Press DIAG, and then press 8 Other diagnostics.
2. Press 3 PMT Sensitivity override to reduce the sensitivity by a specified factor. The PMT Sensitivity screen appears.

## PMT sensitivity screen

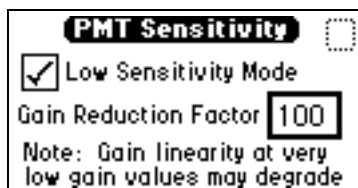

3. Click the Low Sensitivity Mode checkbox.
4. Enter a reduction value of 10 or 100.

## Troubleshooting

---

### Introduction

This section provides some causes of errors and recommended troubleshooting actions. Keep in mind that the source of apparent detector problems lie within the chromatography or your other instruments as well as with the detector.

Most detector problems are relatively easy to correct. If you are unable to correct a problem or failed condition after running the user diagnostics applicable to the problem, contact Waters Technical Service (see [page 4-2](#)).

### Information needed when you contact Waters

To expedite your request for service, keep the following information at hand when you call Waters Technical Service:

- 2475 detector serial number
- Problem symptom(s)
- Operating wavelength pair(s)
- EUFS or measurement range
- Flow rate
- Filter setting
- Type of column
- Operating pressure
- Solvent(s)

- System configuration (other components)

**Tip:** The detector may be configured as part of an Alliance system with an Empower system, a Millennium<sup>32</sup> chromatography workstation, other Waters HPLC components, or a non-Waters product.

## Diagnostic tests

The detector performs some user-selected diagnostic tests to help you troubleshoot basic system problems. [“Overview of diagnostic tests and settings” on page 5-8](#) has diagnostic descriptions and instructions on how to use them. The [table titled “2475 detector diagnostic tests and settings” on page 5-10](#) and the [table titled “General hardware troubleshooting” on page 5-21](#) describe error messages that can appear onscreen as you start up or operate the detector, and it suggests corrective actions.

## Power surges

Power surges, line spikes, and transient energy sources can adversely affect detector operations. Ensure that the electrical supply is properly grounded and free from any of these conditions.

## Hardware troubleshooting

The following table contains general hardware troubleshooting.

### General hardware troubleshooting

Symptom	Possible cause	Corrective action
Analog output incorrect	EUFS setting changed	Reset the EUFS setting.
Calibration or energy error on startup	Flow cell has an air bubble or UV absorber	Flush the flow cell.
	Output units selection is incorrect	Check output mode (home screen 2).

## General hardware troubleshooting (Continued)

Symptom	Possible cause	Corrective action
Detector inoperative	Open (blown) fuse	Ensure the front panel display is operational. Replace the AC rear panel fuses, if necessary.
	No power at outlet	Check outlet by connecting an electrical device known to be in working order and see if it operates.
Front panel display fails to illuminate	Broken electrical connection	Check electrical connections.
	Open (blown) fuse	Check and, if necessary, replace fuse(s).
	Bad LCD or control board	Call Waters Technical Service.
Front panel displays odd characters	Faulty EPROMs or bad LCD control board	Call Waters Technical Service.
Keypad not functioning	Defective keypad	<ol style="list-style-type: none"> <li>1. Power-off and power-on again.</li> <li>2. Run the keypad diagnostic test.</li> <li>3. If the problem persists, call Waters Technical Service.</li> </ol>
No sample and reference energy	Lamp life expired	<ol style="list-style-type: none"> <li>1. Attempt to reignite by selecting Lamp (Shift, 1).</li> <li>2. Replace the lamp.</li> </ol>
	Lamp off	<ol style="list-style-type: none"> <li>1. Check the lamp icon.</li> <li>2. Run the Sample &amp; ref energy diagnostic test.</li> </ol>

## General hardware troubleshooting (Continued)

Symptom	Possible cause	Corrective action
RS-232 problems	Disabled RS-232 configuration	Set the Configuration screen correctly.
	Bad RS-232 cable	Check and, if necessary, replace the RS-232 cable.
Xenon lamp does not light	Faulty lamp	Replace the lamp.
	Lamp not plugged in	Plug in the lamp connector.
	Bad lamp power supply	Contact Waters Technical Service.
	Lamp switch off	Check the rear panel connections.



# A Safety Advisories

Waters instruments display hazard symbols designed to alert you to the hidden dangers of operating and maintaining the instruments. Their corresponding user guides also include the hazard symbols, with accompanying text statements describing the hazards and telling you how to avoid them. This appendix presents all the safety symbols and statements that apply to the entire line of Waters products.

## Contents

Topic	Page
<a href="#">Warning symbols</a>	<a href="#">A-2</a>
<a href="#">Caution symbol</a>	<a href="#">A-5</a>
<a href="#">Warnings that apply to all Waters instruments</a>	<a href="#">A-6</a>
<a href="#">Electrical and handling symbols</a>	<a href="#">A-12</a>

## Warning symbols

---

Warning symbols alert you to the risk of death, injury, or seriously adverse physiological reactions associated with an instrument's use or misuse. Heed all warnings when you install, repair, and operate Waters instruments. Waters assumes no liability for the failure of those who install, repair, or operate its instruments to comply with any safety precaution.

### Task-specific hazard warnings

The following warning symbols alert you to risks that can arise when you operate or maintain an instrument or instrument component. Such risks include burn injuries, electric shocks, ultraviolet radiation exposures, and others.

When the following symbols appear in a manual's narratives or procedures, their accompanying text identifies the specific risk and explains how to avoid it.



**Warning:** (General risk of danger. When this symbol appears on an instrument, consult the instrument's user documentation for important safety-related information before you use the instrument.)



**Warning:** (Risk of burn injury from contacting hot surfaces.)



**Warning:** (Risk of electric shock.)



**Warning:** (Risk of fire.)



**Warning:** (Risk of sharp-point puncture injury.)



**Warning:** (Risk of hand crush injury.)



**Warning:** (Risk of exposure to ultraviolet radiation.)



**Warning:** (Risk of contacting corrosive substances.)



**Warning:** (Risk of exposure to a toxic substance.)



**Warning:** (Risk of personal exposure to laser radiation.)





**Warning:** (Risk of exposure to biological agents that can pose a serious health threat.)



**Warning:** (Risk of tipping.)



**Warning:** (Risk of explosion.)



**Warning:** (Risk of eye injury.)

## Specific warnings

The following warnings can appear in the user manuals of particular instruments and on labels affixed to them or their component parts.

### Burst warning

This warning applies to Waters instruments fitted with nonmetallic tubing.



**Warning:** Pressurized nonmetallic, or polymer, tubing can burst.

Observe these precautions when working around such tubing:

- Wear eye protection.
- Extinguish all nearby flames.
- Do not use tubing that is, or has been, stressed or kinked.
- Do not expose nonmetallic tubing to incompatible compounds like tetrahydrofuran (THF) and nitric or sulfuric acids.
- Be aware that some compounds, like methylene chloride and dimethyl sulfoxide, can cause nonmetallic tubing to swell, which significantly reduces the pressure at which the tubing can rupture.

## Mass spectrometer flammable solvents warning

This warning applies to instruments operated with flammable solvents.



**Warning:** Where significant quantities of flammable solvents are involved, a continuous flow of nitrogen into the ion source is required to prevent possible ignition in that enclosed space.

Ensure that the nitrogen supply pressure never falls below 690 kPa (6.9 bar, 100 psi) during an analysis in which flammable solvents are used. Also ensure a gas-fail connection is connected to the LC system so that the LC solvent flow stops if the nitrogen supply fails.

## Mass spectrometer shock hazard

This warning applies to all Waters mass spectrometers.



**Warning:** To avoid electric shock, do not remove the mass spectrometer's protective panels. The components they cover are not user-serviceable.

This warning applies to certain instruments when they are in Operate mode.



**Warning:** High voltages can be present at certain external surfaces of the mass spectrometer when the instrument is in Operate mode. To avoid non-lethal electric shock, make sure the instrument is in Standby mode before touching areas marked with this high voltage warning symbol.

## Biohazard warning

This warning applies to Waters instruments that can be used to process material that might contain biohazards: substances that contain biological agents capable of producing harmful effects in humans.



**Warning:** Waters instruments and software can be used to analyze or process potentially infectious human-sourced products, inactivated microorganisms, and other biological materials. To avoid infection with these agents, assume that all biological fluids are infectious, observe Good Laboratory Practices, and consult your organization's biohazard safety representative regarding their proper use and handling. Specific precautions appear in the latest edition of the US National Institutes of Health (NIH) publication, *Biosafety in Microbiological and Biomedical Laboratories* (BMBL).

## Chemical hazard warning

This warning applies to Waters instruments that can process corrosive, toxic, flammable, or other types of hazardous material.



**Warning:** Waters instruments can be used to analyze or process potentially hazardous substances. To avoid injury with any of these materials, familiarize yourself with the materials and their hazards, observe Good Laboratory Practices (GLP), and consult your organization's safety representative regarding proper use and handling. Guidelines are provided in the latest edition of the National Research Council's publication, *Prudent Practices in the Laboratory: Handling and Disposal of Chemicals*.

## Caution symbol

---

The caution symbol signifies that an instrument's use or misuse can damage the instrument or compromise a sample's integrity. The following symbol and its associated statement are typical of the kind that alert you to the risk of damaging the instrument or sample.



**Caution:** To avoid damage, do not use abrasives or solvents to clean the instrument's case.

## Warnings that apply to all Waters instruments

---

When operating this device, follow standard quality control procedures and the equipment guidelines in this section.



**Attention:** Changes or modifications to this unit not expressly approved by the party responsible for compliance could void the user's authority to operate the equipment.

**Important:** Toute modification sur cette unité n'ayant pas été expressément approuvée par l'autorité responsable de la conformité à la réglementation peut annuler le droit de l'utilisateur à exploiter l'équipement.

**Achtung:** Jedwede Änderungen oder Modifikationen an dem Gerät ohne die ausdrückliche Genehmigung der für die ordnungsgemäße Funktionstüchtigkeit verantwortlichen Personen kann zum Entzug der Bedienungsbefugnis des Systems führen.

**Avvertenza:** qualsiasi modifica o alterazione apportata a questa unità e non espressamente autorizzata dai responsabili per la conformità fa decadere il diritto all'utilizzo dell'apparecchiatura da parte dell'utente.

**Atencion:** cualquier cambio o modificación efectuado en esta unidad que no haya sido expresamente aprobado por la parte responsable del cumplimiento puede anular la autorización del usuario para utilizar el equipo.

**注意:** 未經有關法規認證部門允許對本設備進行的改變或修改,可能會使使用者喪失操作該設備的權利。

**注意:** 未經有關法規認證部門明確允許對本設備進行的改變或改裝,可能會使使用者喪失操作該設備的合法性。

**주의:** 규정 준수를 책임지는 당사자의 명백한 승인 없이 이 장치를 개조 또는 변경할 경우, 이 장치를 운용할 수 있는 사용자 권한의 효력을 상실할 수 있습니다.

**注意:** 規制機関から明確な承認を受けずに本装置の変更や改造を行うと、本装置のユーザーとしての承認が無効になる可能性があります。



**Warning:** Use caution when working with any polymer tubing under pressure:

- Always wear eye protection when near pressurized polymer tubing.
- Extinguish all nearby flames.
- Do not use tubing that has been severely stressed or kinked.
- Do not use nonmetallic tubing with tetrahydrofuran (THF) or concentrated nitric or sulfuric acids.
- Be aware that methylene chloride and dimethyl sulfoxide cause nonmetallic tubing to swell, which greatly reduces the rupture pressure of the tubing.

**Attention:** Manipulez les tubes en polymère sous pression avec précaution:

- Portez systématiquement des lunettes de protection lorsque vous vous trouvez à proximité de tubes en polymère pressurisés.
- Eteignez toute flamme se trouvant à proximité de l'instrument.
- Evitez d'utiliser des tubes sévèrement déformés ou endommagés.
- Evitez d'utiliser des tubes non métalliques avec du tétrahydrofurane (THF) ou de l'acide sulfurique ou nitrique concentré.
- Sachez que le chlorure de méthylène et le diméthylesulfoxyde entraînent le gonflement des tuyaux non métalliques, ce qui réduit considérablement leur pression de rupture.

**Vorsicht:** Bei der Arbeit mit Polymerschläuchen unter Druck ist besondere Vorsicht angebracht:

- In der Nähe von unter Druck stehenden Polymerschläuchen stets Schutzbrille tragen.
- Alle offenen Flammen in der Nähe löschen.
- Keine Schläuche verwenden, die stark geknickt oder überbeansprucht sind.
- Nichtmetallische Schläuche nicht für Tetrahydrofuran (THF) oder konzentrierte Salpeter- oder Schwefelsäure verwenden.
- Durch Methylenchlorid und Dimethylsulfoxid können nichtmetallische Schläuche quellen; dadurch wird der Berstdruck des Schlauches erheblich reduziert.



**Attenzione:** fare attenzione quando si utilizzano tubi in materiale polimerico sotto pressione:

- Indossare sempre occhiali da lavoro protettivi nei pressi di tubi di polimero pressurizzati.
- Spegnere tutte le fiamme vive nell'ambiente circostante.
- Non utilizzare tubi eccessivamente logorati o piegati.
- Non utilizzare tubi non metallici con tetraidrofurano (THF) o acido solforico o nitrico concentrati.
- Tenere presente che il cloruro di metilene e il dimetilsolfossido provocano rigonfiamenti nei tubi non metallici, riducendo notevolmente la pressione di rottura dei tubi stessi.

**Advertencia:** se recomienda precaución cuando se trabaje con tubos de polímero sometidos a presión:

- El usuario deberá protegerse siempre los ojos cuando trabaje cerca de tubos de polímero sometidos a presión.
- Si hubiera alguna llama las proximidades.
- No se debe trabajar con tubos que se hayan doblado o sometido a altas presiones.
- Es necesario utilizar tubos de metal cuando se trabaje con tetrahidrofurano (THF) o ácidos nítrico o sulfúrico concentrados.
- Hay que tener en cuenta que el cloruro de metileno y el sulfóxido de dimetilo dilatan los tubos no metálicos, lo que reduce la presión de ruptura de los tubos.

**警告:** 當在有壓力的情況下使用聚合物管線時，小心注意以下幾點。

- 當接近有壓力的聚合物管線時一定要戴防護眼鏡。
- 熄滅附近所有的火焰。
- 不要使用已經被壓癟或嚴重彎曲管線。
- 不要在非金屬管線中使用四氫呋喃或濃硝酸或濃硫酸。
- 要了解使用二氯甲烷及二甲基亞楓會導致非金屬管線膨脹，大大降低管線的耐壓能力。



**警告:** 当有压力的情况下使用管线时, 小心注意以下几点:

- 当接近有压力的聚合物管线时一定要戴防护眼镜。
- 熄灭附近所有的火焰。
- 不要使用已经被压瘪或严重弯曲的管线。
- 不要在非金属管线中使用四氢呋喃或浓硝酸或浓硫酸。
- 要了解使用二氯甲烷及二甲基亚砜会导致非金属管线膨胀, 大大降低管线的耐压能力。

**경고:** 가압 폴리머 튜브로 작업할 경우에는 주의하십시오.

- 가압 폴리머 튜브 근처에서는 항상 보호 안경을 착용하십시오.
- 근처의 화기를 모두 끄십시오.
- 심하게 변형되거나 꼬인 튜브는 사용하지 마십시오.
- 비금속(Nonmetallic) 튜브를 테트라히드로푸란(Tetrahydrofuran: THF) 또는 농축 질산 또는 황산과 함께 사용하지 마십시오.
- 염화 메틸렌(Methylene chloride) 및 디메틸설폭시드(Dimethyl sulfoxide)는 비금속 튜브를 부풀려 튜브의 파열 압력을 크게 감소시킬 수 있으므로 유의하십시오.

**警告:** 圧力のかかったポリマーチューブを扱うときは、注意してください。

- 加圧されたポリマーチューブの付近では、必ず保護メガネを着用してください。
- 近くにある火を消してください。
- 著しく変形した、または折れ曲がったチューブは使用しないでください。
- 非金属チューブには、テトラヒドロフラン(THF)や高濃度の硝酸または硫酸などを流さないでください。
- 塩化メチレンやジメチルスルホキシドは、非金属チューブの膨張を引き起こす場合があります、その場合、チューブは極めて低い圧力で破裂します。



**Warning:** The user shall be made aware that if the equipment is used in a manner not specified by the manufacturer, the protection provided by the equipment may be impaired.

**Attention:** L'utilisateur doit être informé que si le matériel est utilisé d'une façon non spécifiée par le fabricant, la protection assurée par le matériel risque d'être défectueuses.

**Vorsicht:** Der Benutzer wird darauf aufmerksam gemacht, dass bei unsachgemäßer Verwendung des Gerätes die eingebauten Sicherheitseinrichtungen unter Umständen nicht ordnungsgemäß funktionieren.

**Attenzione:** si rende noto all'utente che l'eventuale utilizzo dell'apparecchiatura secondo modalità non previste dal produttore può compromettere la protezione offerta dall'apparecchiatura.

**Advertencia:** el usuario deberá saber que si el equipo se utiliza de forma distinta a la especificada por el fabricante, las medidas de protección del equipo podrían ser insuficientes.

**警告:** 使用者必須非常清楚如果設備不是按照製造廠商指定的方式使用，那麼該設備所提供的保護將被削弱。

**警告:** 使用者必須非常清楚如果設備不是按照製造廠商指定的方式使用，那麼該設備所提供的保護將被削弱。

**경고:** 제조업체가 명시하지 않은 방식으로 장비를 사용할 경우 장비가 제공하는 보호 수단이 제대로 작동하지 않을 수 있다는 점을 사용자에게 반드시 인식시켜야 합니다.

**警告:** ユーザーは、製造元により指定されていない方法で機器を使用すると、機器が提供している保証が無効になる可能性があることに注意して下さい。





**Warning:** To protect against fire, replace fuses with those of the type and rating printed on panels adjacent to instrument fuse covers.



**Attention:** pour éviter tout risque d'incendie, remplacez toujours les fusibles par d'autres du type et de la puissance indiqués sur le panneau à proximité du couvercle de la boîte à fusible de l'instrument.



**Vorsicht:** Zum Schutz gegen Feuer die Sicherungen nur mit Sicherungen ersetzen, deren Typ und Nennwert auf den Tafeln neben den Sicherungsabdeckungen des Geräts gedruckt sind.



**Attenzione:** per garantire protezione contro gli incendi, sostituire i fusibili con altri dello stesso tipo aventi le caratteristiche indicate sui pannelli adiacenti alla copertura fusibili dello strumento.



**Advertencia:** Para evitar incendios, sustituir los fusibles por aquellos del tipo y características impresos en los paneles adyacentes a las cubiertas de los fusibles del instrumento.



**警告:** 為了避免火災，更換保險絲時，請使用與儀器保險絲蓋旁面板上所印刷之相同類型與規格的保險絲。



**警告:** 为了避免火灾，应更换与仪器保险丝盖旁边面板上印刷的类型和规格相同的保险丝。



**경고:** 화재의 위험을 막으려면 기기 퓨즈 커버에 가까운 패널에 인쇄된 것과 동일한 타입 및 정격의 제품으로 퓨즈를 교체하십시오.











**警告:** 火災予防のために、ヒューズ交換では機器ヒューズカバー脇のパネルに記載されているタイプおよび定格のヒューズをご使用ください。

# Electrical and handling symbols

---





## Electrical symbols

These can appear in instrument user manuals and on the instrument's front or rear panels.

	Electrical power on
	Electrical power off
	Standby
	Direct current
	Alternating current
	Protective conductor terminal
	Frame, or chassis, terminal
	Fuse
	Recycle symbol: Do not dispose in municipal waste.

## Handling symbols

These handling symbols and their associated text can appear on labels affixed to the outer packaging of Waters instrument and component shipments.

	Keep upright!
	Keep dry!
	Fragile!
	Use no hooks!



# B Specifications

## Physical specifications

Attribute	Specification
Height	20.8 cm (8.2 inches)
Depth	50.3 cm (19.8 inches)
Width	28.4 cm (11.2 inches)
Weight	13.61 kg (30 pounds)

## Environmental specifications

Attribute	Specification
Operating temperature	4 to 40 °C (39.2 to 104 °F)
Operating humidity	20 to 80%, noncondensing
Shipping and storage temperature	-40 to 70 °C (-40 to 158 °F)
Shipping and storage humidity	20 to 80%, noncondensing

## Electrical specifications

Attribute	Specification
Protection class <sup>a</sup>	Class I
Overvoltage category <sup>b</sup>	II
Pollution degree <sup>c</sup>	2
Moisture protection <sup>d</sup>	Normal (IPX0)
 Line voltages, nominal	Grounded AC, 120 V, 240 V, ±10%

## Electrical specifications (Continued)

Attribute	Specification
Altitude	2000 m (6561.6 feet)
Line frequency	50/60 Hz
Fuse ratings	Two fuses: 100 to 240 VAC, 50 to 60 Hz F 3.15 A, 250 V FAST BLO, 5 × 20 mm (IEC)
Power consumption	280 VA (nominal)
Two attenuated analog output channels: 1 VFS	Attenuation range: 1 to 100,000 EUFS 1V output range: -0.1 to +1.1 V
Two event outputs	Type: Contact closure Voltage: +30 V Current: 1 A
Four event inputs	Input voltage: +30 V maximum 100 ms (minimum period)

- a. **Protection Class I** – The insulating scheme used in the instrument to protect from electrical shock. Class I identifies a single level of insulation between live parts (wires) and exposed conductive parts (metal panels), in which the exposed conductive parts are connected to a grounding system. In turn, this grounding system is connected to the third pin (ground pin) on the electrical power cord plug.
- b. **Overvoltage Category II** – Pertains to instruments that receive their electrical power from a local level such as an electrical wall outlet.
- c. **Pollution Degree 2** – A measure of pollution on electrical circuits, which may produce a reduction of dielectric strength or surface resistivity. Degree 2 refers only to normally nonconductive pollution. Occasionally, however, expect a temporary conductivity caused by condensation.
- d. **Moisture Protection** – Normal (IPX0) – IPX0 means that *no* Ingress Protection against any type of dripping or sprayed water exists. The X is a placeholder that identifies protection against dust, if applicable.

## Performance specifications

Attribute	Specification
Wavelength range	Ex: 200 to 890 nm Em: 210 to 900 nm
Bandwidth	20 nm (maximum)
Wavelength accuracy	±3 nm

## Performance specifications (Continued)

Attribute	Specification
Wavelength repeatability	±0.25 nm
Sensitivity, single channel	Ex: 350 nm Em: 397 nm (Signal-to-noise ratio of water Raman peak ≥1000. Hamming filter TC = 1.5 sec)
Sensitivity setting range	1 to 100,000 EUFS
Filter setting range	Single-channel: 0.1 to 5.0 seconds, Hamming (default) 0.1 to 99 seconds, RC Multichannel: 1 to 50 seconds, Hamming (default) 1 to 99 seconds, RC
<b>Optical Component Specifications</b>	
Lamp source	Xenon arc lamp (150 W)
Flow cell	Axial Illuminated Flow Cell design
Cell volume (illuminated)	8 µL (standard analytical)
Pressure limit	145 psi (flow rate not to exceed 5 mL/min)
Materials	316 stainless steel, fused silica, Teflon®





# C Solvent Considerations

## Contents:

Topic	Page
Introduction	C-2
Solvent miscibility	C-3
Buffered solvents	C-6
Head height	C-6
Solvent viscosity	C-6
Mobile phase solvent degassing	C-7
Wavelength selection	C-9

## Introduction

---



**Warning:** To avoid chemical hazards, always observe safe laboratory practices when operating your system.

### Clean solvents

Clean solvents provide

- reproducible results
- operation with minimal instrument maintenance

A dirty solvent can cause

- baseline noise and drift
- blockage of the solvent filters with particulate matter

### Solvent quality

Use HPLC-grade solvents to ensure the best possible results. Filter through 0.22- $\mu\text{m}$  filters before use. Solvents distilled in glass generally maintain their purity from lot to lot; use them to ensure the best possible results.

### Preparation checklist

The following solvent preparation guidelines help to ensure stable baselines and good resolution:

- Filter solvents with a 0.22- $\mu\text{m}$  filter.
- Degas and/or sparge the solvent.
- Stir the solvent.
- Keep solvent in a place free from drafts and shock.

### Water

Use water only from a high-quality water purification system. If the water system does not provide filtered water, filter it through a 0.22- $\mu\text{m}$  membrane filter before use.

## Buffers

When you use buffers, dissolve salts first, adjust the pH, then filter to remove insoluble material.

## Tetrahydrofuran (THF)

When using unstabilized THF, ensure that your solvent is fresh. Previously opened bottles of THF contain peroxide contaminants, which cause baseline drift.



**Warning:** THF contaminants (peroxides) are potentially explosive when concentrated or taken to dryness.

## Solvent miscibility

---

Before you change solvents, consult the following table to determine the miscibility of the solvents to be used. When you change solvents, be aware that:

- Changes involving two miscible solvents may be made directly. Changes involving two solvents that are not totally miscible (for example, from chloroform to water), require an intermediate solvent (such as isopropanol).
- Temperature affects solvent miscibility. If you are running a high-temperature application, consider the effect of the higher temperature on solvent solubility.
- Buffers dissolved in water may precipitate when mixed with organic solvents.

When you switch from a strong buffer to an organic solvent, flush the buffer out of the system with distilled water before you add the organic solvent.

### Solvent miscibility

Polarity index	Solvent	Viscosity CP, 20 °C	Boiling point °C (1 atm)	Miscibility number (M)	$\lambda$ Cutoff (nm)
-0.3	N-decane	0.92	174.1	29	—
-0.4	Iso-octane	0.50	99.2	29	210

### Solvent miscibility (Continued)

Polarity index	Solvent	Viscosity CP, 20 °C	Boiling point °C (1 atm)	Miscibility number (M)	$\lambda$ Cutoff (nm)
0.0	N-hexane	0.313	68.7	29	—
0.0	Cyclohexane	0.98	80.7	28	210
1.7	Butyl ether	0.70	142.2	26	—
1.8	Triethylamine	0.38	89.5	26	—
2.2	Isopropyl ether	0.33	68.3	—	220
2.3	Toluene	0.59	100.6	23	285
2.4	P-xylene	0.70	138.0	24	290
3.0	Benzene	0.65	80.1	21	280
3.3	Benzyl ether	5.33	288.3	—	—
3.4	Methylene chloride	0.44	39.8	20	245
3.7	Ethylene chloride	0.79	83.5	20	—
3.9	Butyl alcohol	3.00	117.7	—	—
3.9	Butanol	3.01	177.7	15	—
4.2	Tetrahydrofuran	0.55	66.0	17	220
4.3	Ethyl acetate	0.47	77.1	19	260
4.3	1-propanol	2.30	97.2	15	210
4.3	2-propanol	2.35	117.7	15	—
4.4	Methyl acetate	0.45	56.3	15, 17	260
4.5	Methyl ethyl ketone	0.43	80.0	17	330
4.5	Cyclohexanone	2.24	155.7	28	210
4.5	Nitrobenzene	2.03	210.8	14, 20	—
4.6	Benzonitrile	1.22	191.1	15, 19	—
4.8	Dioxane	1.54	101.3	17	220
5.2	Ethanol	1.20	78.3	14	210
5.3	Pyridine	0.94	115.3	16	305
5.3	Nitroethane	0.68	114.0	—	—
5.4	Acetone	0.32	56.3	15, 17	330
5.5	Benzyl alcohol	5.80	205.5	13	—

## Solvent miscibility (Continued)

Polarity index	Solvent	Viscosity CP, 20 °C	Boiling point °C (1 atm)	Miscibility number (M)	$\lambda$ Cutoff (nm)
5.7	Methoxyethanol	1.72	124.6	13	—
6.2	Acetonitrile	0.37	81.6	11, 17	210
6.2	Acetic acid	1.26	117.9	14	—
6.4	Dimethylformamide	0.90	153.0	12	—
6.5	Dimethylsulfoxide	2.24	189.0	9	—
6.6	Methanol	0.60	64.7	12	210
7.3	Formamide	3.76	210.5	3	—
9.0	Water	1.00	100.0	—	—

## How to use miscibility numbers

Use miscibility numbers (M-numbers) to predict the miscibility of a liquid with a standard solvent (see the [table titled “Solvent miscibility” on page C-3](#)).

To predict the miscibility of two liquids, subtract the smaller M-number value from the larger M-number value.

- If the difference between the two M-numbers is 15 or less, the two liquids are miscible in all proportions at 15 °C.
- A difference of 16 indicates a critical solution temperature from 25 to 75 °C, with 50 °C as the optimal temperature.
- If the difference is 17 or greater, the liquids are immiscible, or their critical solution temperature is above 75 °C.

Some solvents prove immiscible with solvents at either end of the lipophilicity scale. These solvents receive a dual M-number:

- The first number, always lower than 16, indicates the degree of miscibility with highly lipophilic solvents.
- The second number applies to the opposite end of the scale. A large difference between these two numbers indicates a limited range of miscibility.

For example, some fluorocarbons are immiscible with all the standard solvents and have M-numbers of 0, 32. Two liquids with dual M-numbers are usually miscible with each other.

A liquid is classified in the M-number system by testing for miscibility with a sequence of standard solvents. A correction term of 15 units is then either added or subtracted from the cutoff point for miscibility.

## Buffered solvents

---

When using a buffer, use a good quality reagent and filter it through a 0.22- $\mu\text{m}$  filter.

Do not leave the buffer stored in the system after use. Flush all fluidic pathways with HPLC-quality water before shutting the system down and leave distilled water in the system (flush with 90% HPLC-quality water:10% methanol for shutdowns scheduled to be more than one day). Use a minimum of 15 mL for sparge-equipped units, and a minimum of 45 mL for inline vacuum degasser-equipped units. Some modern systems, such as Waters Alliance<sup>®</sup>, may require volumes lower than this, depending on inline degasser volumes and slow-rate operation limits.

## Head height

---

Position the solvent reservoirs at a level above the HPLC equipment or on top of the pump or detector (with adequate spill protection).



**Warning:** Since the 2475 detector contains a high voltage power source, all solvents should be isolated from the detector.

## Solvent viscosity

---

Generally, viscosity is not important when you are operating with a single solvent or under low pressure. However, when you are running a gradient, the viscosity changes that occur as the solvents are mixed in different proportions can result in pressure changes during the run. For example, a 1:1 mixture of water and methanol produces twice the pressure of either water or methanol alone.

If the extent to which the pressure changes will affect the analysis is not known, monitor the pressure during the run using the Chart Out terminal.

## Mobile phase solvent degassing

---

Mobile phase difficulties account for 70% or more of all liquid chromatographic problems. Using degassed solvents is important, especially at excitation wavelengths below 220 nm. Degassing provides these benefits:

- Stable baselines and enhanced sensitivity
- Reproducible retention times for eluting peaks
- Reproducible injection volumes for quantitation
- Stable pump operation

This section explains the solubility of gases, solvent degassing methods, and solvent degassing considerations.

### Gas solubility

Only a finite amount of gas can be dissolved in a given volume of liquid. This amount depends on:

- The chemical affinity of the gas for the liquid
- The temperature of the liquid
- The pressure applied to the liquid

Changes in the composition, temperature, or pressure of the mobile phase can all lead to outgassing.

### Effects of intermolecular forces

Nonpolar gases ( $N_2$ ,  $O_2$ ,  $CO_2$ , He) are more soluble in nonpolar solvents than in polar solvents. Generally, a gas is most soluble in a solvent with intermolecular attractive forces similar to those in the gas (like dissolves like).

### Effects of temperature

Temperature affects the solubility of gases. If the heat of solution is exothermic, the solubility of the gas decreases when you heat the solvent. If the heat of solution is endothermic, the solubility increases when you heat the solvent. For example, the solubility of He in  $H_2O$  decreases with an increase in

temperature, but the solubility of He in benzene increases with an increase in temperature.

## Effects of partial pressure

The mass of gas dissolved in a given volume of solvent is proportional to the partial pressure of the gas in the vapor phase of the solvent. If you decrease the partial pressure of the gas, the amount of that gas in solution also decreases.

## Solvent degassing methods

This section describes the solvent degassing techniques that will help you attain a stable baseline. Degassing your solvent also improves reproducibility and pump performance. You can use either of the following methods to degas solvents:

- Sparging with helium
- Vacuum degassing

### Sparging

Sparging removes gases from solution by displacing dissolved gases in the solvent with a less soluble gas, usually helium. Well-sparged solvent improves pump performance. Helium sparging brings the solvent to a state of equilibrium, which can be maintained by slow sparging or by keeping a blanket of helium over the solvent. Blanketing inhibits resorption of atmospheric gases.

Sparging can change the composition of mixed solvents.

### Vacuum degassing

The in-line vacuum degasser operates on the principle of Henry's law to remove dissolved gases from the solvent. Henry's law states that the mole fraction of a gas dissolved in liquid is proportional to the partial pressure of that gas in the vapor phase above the liquid. If the partial pressure of a gas on the surface of the liquid is reduced, for example, by evacuation, then a proportional amount of that gas comes out of solution.

Vacuum degassing can change the composition of mixed solvents.



## Solvent degassing considerations

Select the most efficient degassing operation for your application. To remove dissolved gas quickly, consider sparging or vacuum degassing.

### Sparging

In a detector, helium sparging gives stable baselines and better sensitivity than sonication and prevents resorption of atmospheric gases. Use this method to retard oxidation when you are using THF or other peroxide-forming solvents.

### Vacuum degassing

The longer the solvent is exposed to the vacuum, the more dissolved gases are removed. Two factors affect the amount of time the solvent is exposed to the vacuum:

- Flow rate – At low flow rates, most of the dissolved gas is removed as the solvent passes through the vacuum chamber. At higher flow rates, lesser amounts of gas per unit volume of solvent are removed.
- Surface area of the degassing membrane – The length of the degassing membrane is fixed in each vacuum chamber. To increase the length of membrane, you can connect two or more vacuum chambers in series.

The inline degasser is available as an option or factory-installed in the Waters Alliance System.

## Wavelength selection

---

In fluorescence, if the excitation monochromator is set below the UV cutoff of a mobile phase component, the solvent will absorb some of the available excitation light intensity. This will reduce the fluorescence emission response for the sample.

This section includes UV cutoff ranges for:

- Common solvents
- Common mixed mobile phases
- Chromophores

## UV cutoffs for common solvents

The following table shows the UV cutoff (the wavelength at which the absorbance of the solvent is equal to 1 AU for some common chromatographic solvents). Operating at an excitation wavelength near or below the cutoff increases baseline noise due to the solvent's ability to absorb excitation light energy.

### UV cutoff wavelengths for common chromatographic solvents

Solvent	UV Cutoff (nm)	Solvent	UV Cutoff (nm)
1-Nitropropane	380	Ethylene glycol	210
2-Butoxyethanol	220	Iso-octane	215
Acetone	330	Isopropanol	205
Acetonitrile	190	Isopropyl chloride	225
Amyl alcohol	210	Isopropyl ether	220
Amyl chloride	225	Methanol	205
Benzene	280	Methyl acetate	260
Carbon disulfide	380	Methyl ethyl ketone	330
Carbon tetrachloride	265	Methyl isobutyl ketone	334
Chloroform	245	Methylene chloride	233
Cyclohexane	200	<i>n</i> -Pentane	190
Cyclopentane	200	<i>n</i> -Propanol	210
Diethyl amine	275	<i>n</i> -Propyl chloride	225
Dioxane	215	Nitromethane	380
Ethanol	210	Petroleum ether	210
Ethyl acetate	256	Pyridine	330
Ethyl ether	220	Tetrahydrofuran	230
Ethyl sulfide	290	Toluene	285
Ethylene dichloride	230	Xylene	290

## Mixed mobile phases

The following table contains approximate wavelength cutoffs for some other solvents, buffers, detergents, and mobile phases. The solvent concentrations represented are those most commonly used. If you want to use a different concentration, you can determine approximate fluorescence using Beer's law, because fluorescence is proportional to concentration.

### Wavelength cutoffs for different mobile phases

Mobile phase	UV Cutoff (nm)	Mobile phase	UV Cutoff (nm)
Acetic acid, 1%	230	Sodium chloride, 1 M	207
Ammonium acetate, 10 mM	205	Sodium citrate, 10 mM	225
Ammonium bicarbonate, 10 mM	190	Sodium dodecyl sulfate	190
BRIJ 35, 0.1%	190	Sodium formate, 10 mM	200
CHAPS, 0.1%	215	Triethyl amine, 1%	235
Diammonium phosphate, 50 mM	205	Trifluoroacetic acid, 0.1%	190
EDTA, disodium, 1 mM	190	TRIS HCl, 20 mM, pH 7.0, pH 8.0	202, 212
HEPES, 10 mM, pH 7.6	225	Triton-X™ 100, 0.1%	240
Hydrochloric acid, 0.1%	190	Waters PIC® Reagent A, 1 vial/liter	200
MES, 10 mM, pH 6.0	215	Waters PIC Reagent B-6, 1 vial/liter	225
Potassium phosphate, monobasic, 10 mM dibasic, 10 mM	190 190	Waters PIC Reagent B-6, low UV, 1 vial/liter	190
Sodium acetate, 10 mM	205	Waters PIC Reagent D-4, 1 vial/liter	190

## Wavelength selection for chromophore detection

Certain functional groups found in most compounds absorb light selectively. These groups, known as chromophores, and their behavior can be used to categorize the detection of sample molecules. The following table lists some common chromophores and their detection wavelengths ( $\lambda_{\max}$ ), as well as the molar absorptivity ( $\epsilon_{\max}$ ) of each group<sup>1</sup>. Use this information as a guide to select the optimal operating wavelength for a particular analysis. Because of the diversity possible within a given sample, scanning over a range of wavelengths can be necessary to determine the best wavelength for a particular analysis.

## Wavelength selection for chromophore detection

Chromophore	Chemical Configuration	$\lambda_{\max}$ (nm)	$\epsilon_{\max}$ (L/m/cm)	$\lambda_{\max}$ (nm)	$\epsilon_{\max}$ (L/m/cm)
Ether	—O—	185	1000		
Thioether	—S—	194	4600	215	1600
Amine	—NH <sub>2</sub>	195	2800		
Thiol	—SH	195	1400		
Disulfide	—S—S—	194	5500	255	400
Bromide	—Br	208	300		
Iodide	—I	260	400		
Nitrile	—C≡N	160	—		
Acetylide	—C≡C—	175–180	6000		
Sulfone	—SO <sub>2</sub> —	180	—		
Oxime	—NOH	190	5000		
Ethylene	—C=C—	190	8000		
Ketone	>C=O	195	1000	270–285	18–30
Thioketone	>C=S	205	strong		
Esters	—COOR	205	50		

1. Willard, H. H. and others. *Instrumental Methods of Analysis*, 6th ed. Litton Educational Publishing, Inc., 1981. Reprinted by permission of Wadsworth Publishing Co., Belmont, California, 94002.

### Wavelength selection for chromophore detection (Continued)

Chromophore	Chemical Configuration	$\lambda_{\max}$ (nm)	$\epsilon_{\max}$ (L/m/cm)	$\lambda_{\max}$ (nm)	$\epsilon_{\max}$ (L/m/cm)
Aldehyde	—CHO	210	strong	280–300	11–18
Carboxyl	—COOH	200–210	50–70		
Sulfoxide	>S→O	210	1500		
Nitro	—NO <sub>2</sub>	210	strong		
Nitrite	—ONO	220–230	1000–2000	300–400	10
Azo	—N=N—	285–400	3–25		
Nitroso	—N=O	302	100		
Nitrate	—ONO <sub>2</sub>	270 (shoulder)	12		
Allene	—(C=C) <sub>2</sub> — (acyclic)	210–230	21,000		
Allene	—(C=C) <sub>3</sub> —	260	35,000		
Allene	—(C=C) <sub>4</sub> —	300	52,000		
Allene	—(C=C) <sub>5</sub> —	330	118,000		
Allene	—(C=C) <sub>2</sub> — (alicyclic)	230–260	3000–8000		
Ethylenic/ Acetylenic	C=C—C≡C	219	6,500		
Ethylenic/Amido	C=C—C=N	220	23,000		
Ethylenic/ Carbonyl	C=C—C=O	210–250	10,000–20,000		
Ethylenic/Nitro	C=C—NO <sub>2</sub>	229	9,500		



# Index

---

## Symbols

- +/- key [3-15](#)
- ? key [3-11](#), [3-28](#)
- key [3-15](#)

## Numerics

- 2475 detector
  - operating under remote control [3-44](#)
  - setting up [3-18](#)
  - start up procedures [3-2](#)
- 600 Series Pump. *See* Waters 600 Series Pump

## A

- A/B key [3-5](#), [3-13](#)
- accessing secondary functions [3-16](#)
- activating a pulse or rectangular wave [3-26](#)
- active method [3-50](#)
- adjusting
  - analog signal [3-20](#)
  - contrast [3-27](#)
- advancing to the next field [3-15](#)
- Alliance Separations Module
  - generating a chart mark from [2-16](#)
  - generating Auto Zero on inject from [2-15](#)
  - starting a method from [2-17](#)
  - turning the 2475 lamp on or off from [2-17](#)
- analog outputs
  - channel outputs [2-10](#)
  - connections [2-23](#)
  - multiwavelength signal [3-22](#)
  - other parameters [3-20](#)
  - signal adjusting [3-20](#)

- single wavelength signal [3-22](#)
- single-channel [3-20](#)
- analog signals [2-6](#)
- anthracene [3-53](#), [3-64](#)
- audience and purpose [iv](#)
- Auto Zero key [3-12](#)
- automatic second-order filter [1-8](#), [1-9](#)
- auto-optimize gain [1-17](#)
- Auto-Optimize Gain diagnostic [3-41](#)
- auto-zero
  - configuring [3-26](#)
  - connections to 600 Series pump [2-31](#)
  - connections to 717plus Autosampler [2-34](#)
  - function [3-12](#), [3-21](#)
  - offset diagnostic setting [5-10](#), [5-13](#)
  - on inject parameter [3-21](#), [3-23](#)
  - on wavelength changes [3-21](#)
  - on wavelength changes parameter [3-23](#)
  - timed event parameter [3-45](#)

## B

- bandwidth specification [B-2](#)
- benefits of degassing [C-7](#), [C-8](#)
- biohazard warning [A-5](#)
- buffered solvents [C-6](#)
- burst warning [A-3](#)
- Bus SAT/IN module, connecting [2-24](#)

## C

- Calibrate key [3-14](#), [3-35](#)
- calibrating, photomultiplier tube (PMT) [1-12](#)
- calibration
  - errors during startup [3-35](#)

- manual 3-14, 3-35
- Cancel key 3-15
- caution symbol A-5
- CE key 3-15
- change lamp diagnostic test 5-10
- change lamp function 5-16
- changing
  - channel, from multi to single 3-38
  - channel, from single to multi 3-38
  - channels 3-13
  - contrast 3-15
  - filter type 3-16
  - modes 3-38
  - scale on a fluorescence trace 3-13
  - time constant 3-16
  - wavelength, from multi to single 3-12
  - wavelength, from single to multi 3-12
- channel
  - A and B outputs 2-10
  - changing 3-5, 3-13, 3-38
  - on 3-6
  - selector 3-6
- chart mark
  - configuring event inputs 3-26
  - enabling 3-21
  - generating 2-29, 3-12
  - generating from the Alliance Separations Module 2-16
  - Waters 600 Series Pump connections 2-31
- Chart Mark key 3-12
- chart polarity
  - function 3-16, 3-20
  - parameter 3-22
- chart recorder, connecting 2-28–2-29
- charting
  - difference plot 3-20
  - MaxPlot function 3-20
- chemical hazard warning A-5
- chemiluminescence 1-2
- chromatography, fluorescence 1-2
- cleaning the flow cell 4-5
- cleaning, detector exterior 4-15
- Clear Field key 3-15
- clearing
  - editing changes 3-15
  - events 3-51
- column connections 2-3
- CONFIGURE key 3-13, 3-25
- configuring
  - auto-zero event input 3-26
  - detector 3-13
  - event inputs 3-25
  - lamp signal 2-30
- connecting
  - Alliance Separations Module 2-14
  - Alliance system 2-14
  - Bus SAT/IN module 2-24
  - chart recorder 2-28–2-29
  - column 2-3
  - electricity source 2-36
  - Ethernet cable 2-7, 2-20
  - external devices 2-10
  - inject-start 2-9, 2-22
  - Millennium chromatography workstation 2-24
  - multiple Waters instruments 2-8, 2-21
  - other equipment 2-23–2-35
  - signal cables 2-5
  - single Waters instrument 2-7, 2-20
  - Waters 600 Series Pump 2-29–2-33
  - Waters 717plus Autosampler 2-33–2-35
  - Waters 746 data module 2-27–2-28
- connections, signal 2-13



- conserving lamp life 3-67
- contact closures
  - and events diagnostic setting 5-10
  - configuring event inputs 3-25
  - monitoring 5-14
- contacting Waters Technical Service 4-2, 5-20
- context-sensitive Help 3-28
- contrast
  - adjusting 3-27
  - changing 3-15
  - function 3-27
- Contrast key 3-15
- controlling
  - from data systems 3-1
  - from older external data systems 3-29
- cooling off the lamp 4-9
- cover, removing 4-4
- CPU board 1-13
- current method conditions 3-16, 3-44, 3-51

## D

- damage
  - to the flow cell 4-7
- damage, reporting 4-2
- data system control 3-1
- data units 3-19
- data units selection 3-16
- DC power supply 1-14
- decimal point key 3-15
- degassing
  - benefits 1-21, C-7, C-8
  - considerations C-9
- deleting a timed event 3-47
- design
  - electronic 1-9
  - optical 1-9
- detector

- exterior, cleaning 4-15
- overview 1-7
- setup 2-2
- DIAG key 3-13
- diagnostic settings
  - auto-zero offset 5-10, 5-13
  - contact closures and events 5-10
  - fix (set) EU 5-10
  - fix (set) voltage 5-10
  - input and output 5-12
  - optical filter override 5-11
  - procedure 5-8–5-20
  - reset 5-10
  - setting a fixed voltage output 5-14
  - sticky 5-9
  - user-selected 5-8–5-20
- diagnostic tests
  - change lamp 5-10
  - failure 3-3, 5-2
  - generating test peaks 5-11
  - input and output 5-10, 5-12
  - keypad 3-13
  - keypad test 5-10
  - lamp, display, and keypad 5-10
  - procedure 5-8–5-20
  - reducing PMT sensitivity 5-19
  - sample and reference energy 5-10, 5-11
  - service 5-11
  - startup 1-21, 3-2
  - sticky 3-8
  - test display 5-10, 5-17
  - test keypad 5-16
  - user-selected 5-8–5-20
  - using 5-1–5-23
- difference plot 1-16, 3-20
- diffraction grating 1-9
- dirty flow cell 4-5
- disabling

- external events [3-16](#)
- inputs [3-16](#)
- disassembling the flow cell [4-8](#)
- display
  - diagnostic test [5-10](#), [5-17](#)
  - fluorescence trace [3-13](#)
  - lamp use statistics [3-14](#)
  - options [3-13](#)
  - system information [3-28](#)
  - test [5-10](#)
  - testing [5-17](#)
- E**
- EC Authorized Representative [vi](#)
- electrical
  - specifications [B-1](#)
- electrical symbols [A-12](#)
- electricity source, connecting [2-36](#)
- electronics [1-13](#)
- emission [3-19](#), [3-20](#)
  - monochromator [1-11](#)
  - monochromator optics [1-10](#)
  - units [1-5](#)
  - wavelength selection [1-4](#)
  - wavelength, field [3-5](#)
- enabling
  - chart mark [3-21](#)
  - chart mark event inputs [3-26](#)
  - external events [3-16](#)
  - inputs [3-16](#)
- ending wavelength [3-52](#)
- energy sources, excitation [1-3](#)
- energy units [1-6](#), [3-19](#)
- Enter key [3-15](#)
- entering negative numbers [3-15](#)
- entrance slits [1-9](#)
- environmental specifications [2-2](#), [B-1](#)
- equipment guidelines [iv](#), [A-6](#)
- erbium

- filter [1-8](#)
  - scan [3-53](#)
- error messages [5-1–5-23](#)
- errors
  - calibration [3-35](#)
  - startup [3-35](#), [5-2](#)
- Ethernet
  - communications interface [1-13](#)
- Ethernet cable, connecting [2-7](#), [2-20](#)
- EU [1-5](#)
- EUFS
  - defined [3-19](#)
  - function [3-19](#)
  - parameter [3-21](#)
  - sensitivity [3-53](#)
- event inputs
  - auto-zero [3-26](#)
  - chart mark [3-26](#)
  - configuring [3-25](#)
  - functions [2-10](#)
  - inject-start [3-25](#)
  - lamp [3-26](#)
- excitation
  - energy sources [1-3](#)
  - light sources [1-3](#)
  - monochromator [1-11](#)
  - monochromator optics [1-10](#)
  - wavelength selection [1-3](#)
- exit slits [1-9](#)
- external events
  - disabling [3-16](#)
  - enabling [3-16](#)
- F**
- failure of startup diagnostic tests [3-3](#)
- fields, emission wavelength [3-5](#)
- filter type
  - changing [3-16](#)
  - function [3-19](#)

- parameter 3-21
- filters
  - changing the filter type 3-16
  - erbium 1-8
  - filter setting specification B-3
  - optical override 5-11, 5-18
  - second-order 1-8, 1-9
  - time constant 3-20
  - types of 3-19
- fix (set) EU diagnostic setting 5-10
- fix (set) voltage diagnostic setting 5-10
- flammable solvents A-4
- flow cell 1-4, 1-9, 1-11
  - cleaning 4-5
  - damaged 4-7
  - dirty 4-5
  - disassembling 4-8
  - flushing 4-5
  - inspecting 4-5
  - passivating 4-5
  - reassembling 4-8
  - replacing 4-7
  - replacing parts 4-5
- flow cell assembly, removing 4-6
- fluorescence 1-2
  - chromatography 1-2
  - difference plot 3-20
  - MaxPlot function 3-20
  - normalized units 1-5
  - process of detection 1-2
  - threshold events 3-46
  - threshold timed event parameter 3-46
  - trace 3-13
- Fluorescence screen
  - display 3-11
  - icons 3-5
- flushing, flow cell 4-5
- front-left-hand panel cover 4-4

- functions
  - analog outputs, single-channel 3-20
  - auto-zero on wavelength changes 3-21
  - change lamp 5-16
  - generating test peaks 5-17
  - MaxPlot 3-20, 3-39
  - optical filter override 5-18
  - primary 3-19
  - secondary 3-19
  - time constant 3-20
  - zoom 3-23
- fuses, replacing 4-14

## G

- gas solubility C-7–C-8
- gases, sparging C-8
- generating
  - Auto Zero on inject from the Alliance Separations Module 2-15
  - chart mark from the Alliance Separations Module 2-16
  - chart marks 2-29, 3-12
  - spectra 3-12
  - test peak diagnostic test 5-11
  - test peaks 5-17
  - tick marks 3-53
- grating
  - diffraction 1-9
  - monochromator 1-3

## H

- handling symbols A-13
- Help key 3-11, 3-28
- HOME key 3-5, 3-11, 3-16
- Home screen 3-4
- home screen 3-4
  - navigating from 3-16
  - secondary pages 3-19

## I

I/O signals [2-11](#)

icons

channel on [3-6](#)

channel selector [3-6](#)

keypad lock [3-8](#)

keypad unlock [3-8](#)

lamp off [3-7](#)

lamp on [3-6](#)

local/remote control [3-8](#)

method number [3-8](#), [3-44](#)

next [3-8](#)

run time [3-8](#)

shift [3-7](#)

sticky diagnostic tests [3-8](#)

table of [3-5](#)

wrench [3-8](#)

idle mode [1-8](#)

initial method conditions [3-12](#), [3-25](#),  
[3-50](#)

initializing the detector [3-2](#)

initiating a scan [3-12](#)

inject signal [3-25](#)

inject-start

connection [2-9](#), [2-22](#)

signal [2-9](#), [2-22](#)

Waters 600 Series Pump  
connections [2-32](#)

Waters 717plus Autosampler  
connections [2-35](#)

input and output diagnostic  
settings [5-12](#)

tests [5-10](#), [5-12](#)

inputs

disabling [3-16](#)

enabling [3-16](#)

signals [2-11](#)

inspecting, flow cells [4-5](#)

installation

columns [2-3](#)

network guidelines [2-8](#), [2-21](#)

installing a new lamp [4-12](#)

intended use [v](#)

inverting the chart [3-16](#), [3-20](#)

ISM classification [v](#)

## K

keypad

+/- key [3-15](#)

? key [3-11](#), [3-28](#)

• key [3-15](#)

A/B key [3-5](#), [3-13](#)

Auto Zero key [3-12](#)

Calibrate key [3-14](#), [3-35](#)

Cancel key [3-15](#)

CE key [3-15](#)

Chart Mark key [3-12](#)

Clear Field key [3-15](#)

CONFIGURE key [3-13](#), [3-25](#)

Contrast key [3-15](#)

decimal point key [3-15](#)

description [3-11](#)

DIAG key [3-13](#)

Enter key [3-15](#)

functions [3-9](#), [3-11](#)

Help key [3-11](#), [3-28](#)

HOME key [3-11](#)

$\lambda/\lambda$  key [3-12](#), [3-37](#), [3-38](#)

Lamp key [3-14](#)

lamp, display, and keypad  
diagnostic tests [5-10](#)

Lock key [3-14](#)

locking [3-14](#)

METHOD key [3-13](#), [3-46](#)

Next key [3-13](#)

numerical keys [3-14](#)

Previous key [3-13](#)

Reset key [3-12](#)

- Run/Stop key 3-12
- Scale key 3-13, 3-23
- SCAN key 3-12, 3-54
- Shift key 3-13
- System Info key 3-14
- test 5-16
- test diagnostic test 5-10
- TRACE key 3-13, 3-23
- up/down arrow keys 3-12
- using 3-9

keypad lock icon 3-8

keypad unlock icon 3-8

## L

$\lambda/\lambda\lambda$  key 3-12, 3-37, 3-38

lamp

- change 5-16
- change lamp diagnostic test 5-10
- configuring lamp event inputs 3-26
- conserving lamp life 3-67
- cooling time 4-9
- energy 1-16
- installing 4-12
- lamp, display, and keypad
  - diagnostic tests 5-10
- new 4-12
- performance 1-16
- removing 4-9
- replacing 4-8
- serial number 4-13
- timed event parameter 3-45
- turning off 3-67–3-70
- turning on or off 3-14
- turning on or off from the Alliance
  - 2-17
- use statistics 3-14
- warranty 4-13

Lamp key 3-14

lamp off icon 3-7

lamp on icon 3-6

lamp on/off connections to 600 Series

- Pump 2-30

light filters 1-3

light sources, excitation 1-3

line spikes 5-21

local/remote control icon 3-8

lock icon 3-8

Lock key 3-14

locking the keypad 3-14

long-pass filter 1-3

loss of current method conditions 3-51

## M

maintenance

- considerations 4-2
- routine 4-3

manual calibration 3-14, 3-35

manual wavelength calibration 1-14

mass spectrometer shock hazard A-4

MaxPlot 1-15

MaxPlot function

- charting 3-20
- obtaining 3-39

method

- active 3-50
- current conditions 3-16
- initial conditions 3-25, 3-50
- list 3-13
- method \* 3-44, 3-50
- preventing loss of current
  - conditions 3-51
- programming 3-43–3-52
- resetting a stored 3-51
- retrieving 3-50
- storing 3-44, 3-49
- viewing events within 3-50

METHOD key 3-13, 3-46

method number icon 3-8, 3-44

method optimization 1-18

mirrors, ellipsoidal and parabolic 1-9  
miscibility of solvents C-3–C-6  
mode  
    idle 1-8  
    multichannel 1-15  
    multiwavelength 1-15  
    single-channel 1-14  
modes, changing 3-38  
monitoring contact closures 5-14  
monochromator  
    emission 1-11  
    excitation 1-11  
    overview 1-3  
moving to the last entry in a list 3-15  
multichannel  
    mode 1-15  
    operation 1-5  
multichannel mode, changing to single  
    3-38  
multiple Waters instruments,  
    connecting 2-8, 2-21  
multiwavelength mode 1-15  
    description 3-12  
    key 3-12

## N

navigating  
    from the home screen 3-16  
    in reverse order 3-13  
    the user interface 3-16  
negative number entry 3-15  
network, installation guidelines 2-8,  
    2-21  
new timed event 3-46  
Next arrow 3-13  
Next icon 3-8  
Next key 3-13  
noise  
    adjusting filter 3-20

    filters 3-19  
    specifications B-3  
noise, filtering 1-12  
normalized units of fluorescence 1-5  
numerical keys 3-14

## O

obtaining  
    MaxPlot 3-39  
    stored spectrum information 3-66  
offset  
    auto-zero offset diagnostic setting  
        5-10  
    voltage 3-16  
operating  
    as a stand-alone instrument 3-29  
    in single wavelength mode 3-38  
    in single-channel mode 3-37  
    modes 3-29  
    under remote control 3-44  
operation, theory and principles of 1-1  
optical  
    and electronic design 1-9  
    component specifications B-3  
    filter override 5-18  
    filter override diagnostic setting  
        5-11  
optics 1-9  
optics assembly  
    emission monochromator 1-10  
    excitation monochromator 1-10  
    light path 1-10  
optimization, method 1-18  
other equipment, connecting 2-23–2-35  
output  
    connections 2-10  
    signals 2-11  
output off 3-20  
overriding, optical filter setting 5-18

## P

pace 3-52

parameters

analog out (multiwavelength) 3-22

analog out (single wavelength) 3-22

auto-zero on inject 3-21, 3-23

auto-zero on wavelength changes  
3-23

auto-zero timed event 3-45

chart polarity 3-22

EUFS 3-21

filter type 3-21

fluorescence threshold timed event  
3-46

lamp timed event 3-45

polarity timed event 3-45

primary 3-21

sample scan 3-55–3-56

secondary 3-21

sensitivity timed event 3-45

SW1 timed event 3-45

SW2 timed event 3-45

time constant 3-22

time constant timed event 3-45

timed event 3-44

voltage offset 3-22

wavelength 3-21

wavelength timed event 3-44

zero-scan 3-54

passivating

flow cell 4-5

peaks, generating test 5-11, 5-17

performance specifications B-2

performing verification procedures  
3-34

personality board 1-13

photomultiplier tube 1-4, 1-9

calibrating 1-12

gain setting 1-17

sensitivity 1-12

physical specifications B-1

plus/minus key 3-15

PMT 1-4, 1-9

calibration 1-12

gain setting 1-17

sensitivity 1-12

sensitivity, reducing 5-19

polarity timed event parameter 3-45

polarity, chart 3-16, 3-20

power

supply 1-14

surges 5-21

power cord 2-36

powering off 3-70

preamplifier board 1-13

preventing loss of current method  
conditions 3-51

Previous key 3-13

primary functions 3-19, 3-21

principles of operation 1-1

programming

switches 3-26

threshold events 3-47

timed events and methods  
3-43–3-52

pulse periods, setting 3-26

purpose and audience iv

## Q

quantitation 1-4

## R

rear panel

illustration 2-10

signal connections 2-10

reassembling the flow cell 4-8

recalling the Fluorescence screen 3-5

recording new lamp's serial number  
4-13

- rectangular wave signal 3-26
- reducing PMT sensitivity 5-19
- reference energy 3-20, 3-56
- remote control 3-44
- removing
  - flow cell assembly 4-6
  - front-left-hand panel cover 4-4
  - lamp 4-9
- repeatability specifications B-3
- replacing
  - flow cell 4-7
  - flow cell parts 4-5
  - front-left-hand panel cover 4-4
  - fuses 4-14
  - lamp 4-8
- replaying a spectrum 3-67
- reservoirs, positioning C-6
- reset diagnostic settings 5-10
- Reset key 3-12
- resetting
  - run clock 3-12
  - stored method 3-51
- retrieving a method 3-50
- returning to initial conditions 3-12
- reviewing a scan 3-66
- run clock, stopping 3-12
- run time icon 3-8
- Run/Stop key 3-12
- running, new scan 3-57–3-63

**S**

- safety advisories A-1
- safety considerations, maintenance 4-2
- sample and reference energy diagnostic
  - tests 5-10, 5-11
- sample energy 3-56
- sample scan
  - procedure 3-55–3-56
  - screens 3-55
    - when to run 3-56
- sample, exciting 1-4
- Scale key 3-13, 3-23
- scale, zooming 3-62
- scaling factor 3-13
- SCAN key 3-12, 3-54
- scanning
  - anthracene 3-53, 3-64
  - erbium 3-53
  - EUFS 3-53
  - initiating 3-12
  - new spectra 3-57–3-63
  - pace 3-52
  - reference energy 3-56
  - replaying a spectrum 3-67
  - reviewing a scan 3-66
  - sample energy 3-56
  - sample scan 3-55–3-56
  - screens 3-55
  - sensitivity 3-53
  - spectra 3-52–3-64
  - storing a scan 3-65
  - subtracting 3-67
  - tick marks 3-53
  - timing 3-56
  - zero-scan 3-54
- screen, Fluorescence (home) 3-4
- secondary functions 3-16, 3-19, 3-21
- secondary pages 3-19
- second-order filter 1-8, 1-9
- selectivity 1-4
- sensitivity 1-4
  - EUFS parameter 3-21
  - scanning 3-53
  - setting specification B-3
  - timed event parameter 3-45
- serial number, lamp 4-13
- service
  - contacting Waters 5-20



- diagnostic tests 5-11
- set EU diagnostic setting 5-10
- set voltage diagnostic setting 5-10
- setting
  - a fixed voltage output 5-14
  - pulse periods 3-26
  - switches 5-14
  - the detector up to run 3-18
- shift icon 3-7
- Shift key 3-13
- shutting down the detector 3-70
- signal
  - cables, connecting 2-5
  - connections 2-5
  - input 2-11
  - output 2-11
  - start of run 3-25
- signal connections
  - inject-start 2-9, 2-22
  - making 2-13
- single pulse signal 3-26
- single Waters instrument, connecting 2-7, 2-20
- single wavelength mode
  - key 3-12
  - operating in 3-38
- single wavelength pair mode 3-12
- single-channel mode 1-14
  - changing to multi 3-38
  - operating in 3-37
  - parameters 3-20
- slits, entrance 1-9
- slits, exit 1-9
- solvent
  - buffered solvents C-6
  - guidelines C-2
  - miscibility C-3–C-6
  - reservoirs C-6
  - UV cutoff C-9–C-11
  - viscosity considerations C-6
- spare parts 4-3
- sparging, overview C-8
- specifications
  - bandwidth B-2
  - electrical B-1
  - environmental B-1
  - filter setting B-3
  - noise B-3
  - optical component B-3
  - performance B-2
  - physical B-1
  - repeatability B-3
  - sensitivity setting B-3
  - wavelength accuracy B-2
  - wavelength range B-2
- specifications, environmental 2-2
- spectra
  - generating 3-12
  - new 3-57–3-63
  - obtaining information about 3-66
  - replaying 3-67
  - reviewing 3-66
  - scanning 3-52–3-64
  - storing 3-65
  - subtracting 3-67
- spectrum, scanning 1-16
- stand-alone operation 3-1, 3-29
- starting
  - detector 3-2
  - methods from the Alliance 2-17
  - run 3-25
  - run clock 3-12
  - wavelength 3-52
- startup
  - diagnostic test failure 3-3
  - diagnostic tests 3-2
  - errors 3-35, 5-2
  - kit 2-27, 2-28

- startup diagnostic tests 1-21
- sticky diagnostic settings 5-9
- sticky diagnostic tests 3-8
- stopping the run clock 3-12
- stored spectra
  - obtaining information 3-66
  - reviewing information 3-66
- storing
  - methods 3-44, 3-49
  - spectra 3-65
- subtracting a spectrum 3-67
- switch 1 timed event parameter 3-45
- switch 2 timed event parameter 3-45
- switched outputs 2-10
- switches
  - programming 3-26
  - setting 5-14
- symbols
  - caution A-5
  - electrical A-12
  - handling A-13
  - warning A-2
- system
  - displaying information 3-14
  - information 3-28
- System Info key 3-14

## T

- Technical Service 5-20
- test display diagnostic test 5-10
- test keypad diagnostic test 5-16
- test peaks, generating 5-17
- theory of operation 1-1
- threshold events
  - clearing 3-51
  - programming 3-47
- tick marks, generating 3-53
- time constant
  - changing 3-16

- function 3-20
- parameter 3-22
- timed event parameter 3-45

timed events

- and methods 3-43–3-52
- clearing 3-51
- deleting 3-47
- description 3-44
- lamp parameters 3-45
- parameters 3-44, 3-46
  - auto-zero 3-45
  - polarity 3-45
  - sensitivity 3-45
  - time constant 3-45
  - wavelength 3-44
- programming 3-43–3-52
- programming a new event 3-46
- switch 1 parameters 3-45
- switch 2 parameters 3-45

toggling between channels 3-5

TRACE key 3-13, 3-23

transient energy 5-21

troubleshooting

- contacting Waters 5-20
- diagnostic tests 5-1–5-23
- hardware 5-21

turning lamp on or off

- from an external device 3-26
- from front panel 3-14
- to conserve lamp life 3-67–3-70

## U

- unlock icon 3-8
- up/down arrow keys 3-12
- user interface 3-16
- user-selected diagnostic
  - settings 5-8–5-20
  - tests 5-8–5-20
- using

- 2475 detector with older external data systems [3-29](#)
- A/B key [3-5](#)
- diagnostic tests [5-1–5-23](#)
- input and output diagnostic settings [5-12](#)
- input and output diagnostic tests [5-12](#)
- keypad [3-9](#)
- sample and reference energy diagnostic tests [5-11](#)
- scale function to zoom [3-23](#)

## V

- vacuum degassing. *See* degassing
- verifying
  - detector [3-34](#)
- viewing events within a method [3-50](#)
- voiding the warranty [4-13](#)
- voltage offset
  - function [3-16](#), [3-20](#)
  - parameter [3-22](#)

## W

- warm up time [3-3](#)
- warning symbols [A-2](#), [A-6](#)
- warranty
  - lamp [4-13](#)
  - voiding [4-13](#)
- Waters 600 Series Pump
  - auto-zero connections [2-31](#)
  - chart mark connections [2-31](#)
  - configuring the detector lamp signal [2-30](#)
  - connecting [2-29–2-33](#)
  - inject-start connections [2-32](#)
  - lamp on/off connections [2-30](#)
- Waters 717plus Autosampler
  - auto-zero connections [2-34](#)
  - connecting [2-33–2-35](#)

- inject- start connections [2-35](#)
- Waters 746 data module, connecting [2-27–2-28](#)
- Waters Technical Service, contacting [4-2](#), [5-20](#)
- wavelength
  - accuracy specifications [B-2](#)
  - calibration [3-14](#), [3-35](#)
  - changes, auto-zero on [3-21](#)
  - changing [3-12](#)
  - ending [3-52](#)
  - parameter [3-21](#)
  - range specifications [B-2](#)
  - selection [1-22](#), [C-9–C-11](#)
    - emission [1-4](#)
    - excitation [1-3](#)
  - starting [3-52](#)
  - timed event parameter [3-44](#)
  - verification failure message [1-14](#)
- wrench icon [3-8](#)

## X

- xenon lamp
  - installing [4-12](#)
  - optics [1-9](#)

## Z

- zero-scan
  - parameters [3-54](#)
  - screens [3-55](#)
- zoom function [3-23](#), [3-62](#)

